

BROADCAST[®]
t o o l s **INC**
PROBLEM SOLVED

Installation and Operation Manual

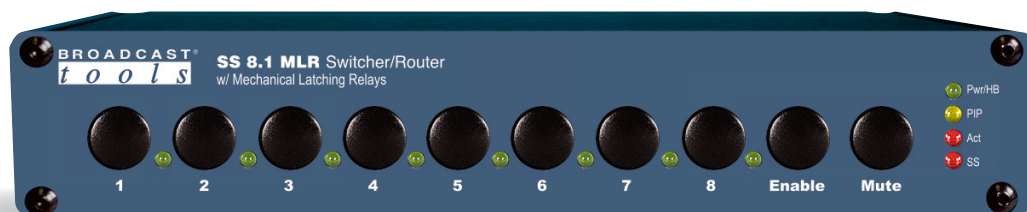

SS 8.1 MLR **Switcher/Router with Mechanical Latching Relays**

Manual update: 7/30/2013

Firmware Version 1.2 and above. If you need a firmware upgrade, contact Broadcast Tools®

No part of this document may be reproduced or distributed without permission.
ALL SPECIFICATIONS AND FEATURES FOR THIS PRODUCT ARE SUBJECT TO
CHANGE WITHOUT NOTICE

NOTE: We recommend the use of Chrome, Firefox or Safari as your browser.

Due to the dynamic nature of product design, the information contained in this document is subject to change without notice. Broadcast Tools, Inc., assumes no responsibility for errors and/or omissions contained in this document. Revisions of this information or new editions may be issued to incorporate such changes.

*Broadcast Tools® is a registered trademark of Broadcast Tools, Inc.
tiny TOOLS™ is a trademark of Broadcast Tools, Inc.
All Sentinel® labeled products are registered trademarks of Broadcast Tools, Inc.
Copyright® 1989 - 2014 by Broadcast Tools, Inc. All rights reserved.
No part of this document may be reproduced or distributed without permission.*

Visit www.broadcasttools.com for important product update information.

Table of Contents

Section Title	Page #
Introduction	3
Safety Information	3
Who to Contact for Help	3
Product Overview	4
Features/Benefits.	4
Applications	4
Inspection	5
Installation.	5
Surge Protection	5
UPS standby power system	5
Installation/Operation	5
Input selection push buttons	5
LED indicators	5
Power	5
I/O Connections	6
Audio Inputs and Output	6
PIP (GPI)/Remote Control Inputs.	6
Open Collector Outputs	7
Configuration jumper setup	8
Configuration Dip-switch setup	8
Serial Operation	9
RS-232 Control.	9
Serial commands.	9
Menu Operation	10
Specifications	11
Warranty	12
Front and rear panel drawings	Appendix
Configuration jumpers and Dip-switch layout	Appendix
Fractional schematic	Appendix

WEBSITE:
Visit our web site for product updates and additional information.

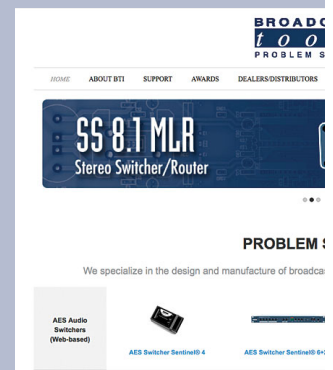

INTRODUCTION

Thank you for your purchase of a BROADCAST TOOLS® SS 8.1 MLR transparent eight input, one output switcher/router (referred to as the SS 8.1 MLR throughout this manual). We're confident that this product will give you many years of dependable service. This manual is intended to give you all the information needed to install and operate the BROADCAST TOOLS® SS 8.1 MLR.

SAFETY INFORMATION

Only qualified technical personnel should install the SS 8.1 MLR. Any attempt to install this device by a person who is not technically qualified could result in a hazardous condition to the installer or other personnel or damage to the SS 8.1 MLR or other equipment. Please ensure that proper safety precautions have been taken before installing this device. If you are unfamiliar with this type of equipment, please contact a properly qualified engineer to handle the installation and setup of the SS 8.1 MLR. Broadcast Tools, Inc., is unable to support NON-Broadcast Tools software, hardware or NON-Broadcast Tools computer/hardware/software problems. If you experience these problems, please research your hardware/software instruction manuals or contact the manufacturers technical support department.

WHO TO CONTACT FOR HELP

If you have any questions regarding your product or you need assistance, please contact your distributor from whom you purchased this equipment. If you would like more information about BROADCAST TOOLS® products, you may reach us at:

Broadcast Tools, Inc.

131 State Street
Sedro-Woolley, WA 98284-1503 USA
Voice: 360.854.9559
Fax: 866.783.1742

Internet Home Page: www.broadcasttools.com
E-mail: support@broadcasttools.com

**THANK YOU FOR CHOOSING
BROADCAST TOOLS® BRAND PRODUCTS!**

Broadcast Tools is a Veteran Owned Business



Designed, Assembled and Supported in WA State, USA



CAUTION!

Broadcast Tools® Products, as with any electronic device, can fail without warning. Do not use this product in applications where a life threatening condition could result due to failure.



NOTE:

This manual should be read thoroughly before installation and operation.

WEBSITE:

Visit our web site for product updates and additional information.

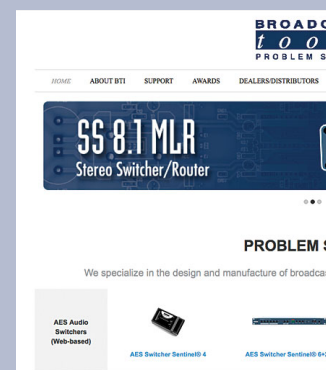

INTRODUCTION

Product Overview

The SS 8.1 MLR is a transparent eight input, single output switcher/router with mechanical latching relays. The SS 8.1 MLR is perfect for all types of passive signal switching controlled via front panel switches, contact closures and/or multi-drop RS-232 serial. Switching is accomplished with mechanical latching gold contact relays, which means that the unit can route a signal in either direction and will keep routing signals even after losing power. Due to the passive nature of the switching, any input level and impedance can be used. Inputs may be balanced or unbalanced, while output levels, impedance, distortion, noise and balancing will match that of the selected input.

Features/Benefits

- Front panel channel selection push buttons with active channel LED indicators.
- Audio “MUTE” function allows the user to turn off all audio.
- Front panel Enable switch can be configured to provide a safety lock to the front panel selection push buttons.
- Audio/signal switching via sealed mechanical latching relays utilizing 2-form-C bifurcated - crossbar silver alloy with gold overlay contacts.
- Internal silence sensor with front panel LED indicator, SPDT/SPST silence sensor alarm relay with adjustable alarm delay and restore duration. May be disabled.
- Eight input GPI port (PIP or Remote Control) with LED indicator.
- Remote control via contact closures, 5-volt TTL/CMOS logic levels and/or the multi-drop RS-232 serial port.
- Eight open collector outputs for remote channel status.
- Removable euro-block screw terminal connectors are used for audio/signal I/O and remote control connections, except RS-232 Serial. Necessary mating plugs are supplied.
- Power-up selection of inputs to outputs, mute or last source selected. If power is lost, the last selected channel is passed to the output.
- Fully RFI proofed.
- Surge protected internal power supply, universal switching power adapter with domestic connector supplied. International connectors optional.
- Up to two units may be mounted on the optional RA-1 rack shelf. Desk top and wall mounting is also possible.

Applications

Automation source switching with eight trigger inputs; Studio selection and routing; Audio processing selection; Exciter input selection; Remote broadcast input selection; STL source selection; Multiple station program on-hold and/or PA switching; EAS audio switching; ISDN or Phone hybrid feed selection; IFB selection; Satellite audio channel switching and console monitor input and output selection.

Inspection

Please examine your SS 8.1 MLR carefully for any damage that may have been sustained during shipping. If any damage is present, please notify the shipper immediately and retain the packaging for inspection by the shipper. The package should contain the SS 8.1 MLR, a modular cable with 9-pin “S9” female D-sub adapter, a 9 VDC wall transformer and a quick start guide. Manuals may be downloaded from our web site.

WEBSITE:

Visit our web site for product updates and additional information.

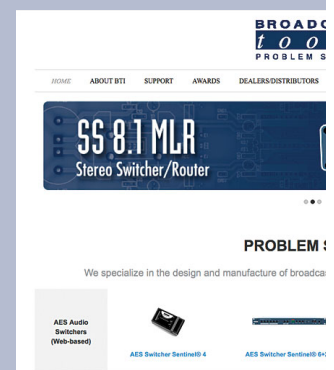

OVERVIEW

Installation

Surge Protection

The SS 8.1 MLR has built-in resistance to voltage changes; we recommend that you use a power surge protector or line conditioner on the incoming AC line. Lightning strikes and/or other high voltage surges may damage your SS 8.1 MLR and connected equipment if it is not properly protected. For lightning protection devices, check out www.polyphaser.com and www.itwlinx.com.

UPS Standby Power System

We recommend that you connect your SS 8.1 MLR to a UPS system. A UPS helps minimize the risk to the SS 8.1 MLR and provides power during a power outage.

NOTE: If power is lost, the last selected channel is passed to the output.

Installation/Operation

Input selection push buttons

Each push button represents an input to be routed to the switcher's output, along with the mute and enable push button. Each push button has an associated LED indicator, which will illuminate when that particular channel is selected. When a channel is selected, the previous channel is deselected (interlock). The enable (safety) push button can be enabled to require the user to hold down the enable push button while selecting any of the other front panel push buttons, the enable LED is illuminated when this function is enabled.

LED indicators

- "PWR" LED: Illuminates when power is applied and blinks when serial data is active.
- "PIP" LED: Flashes to indicate PIP activity.
- "SS": Silence Sensor indicator LED.
- "Enable" LED: Illuminates when the front panel enable push button option is enabled.
- Channel and Mute LED's illuminate when the input channel is selected.

Power

Connect the 2.1mm barrel type power connector into the unit and the 7.5 to 12 VDC universal switching power supply with domestic connector into a 120 Vac 50-60 Hz power source. Never use any type of power supply other than the specified/supplied power supply.

I/O Connections

The rear panel contains all the inputs, outputs and remote control interfacing connectors. The multi-drop serial port is equipped with a modular RJ-11 jack.

Audio Inputs and Output

The SS 8.1 MLR interfaces to external equipment through removable euroblock screw terminals. The terminals accommodate wire sizes from 16 - 28 AWG solid or stranded wire. Before installing a wire, remove the euroblock screw terminal plug and turn each capture screw fully counterclockwise. Strip each conductor to a length of 0.25" and insert the conductor fully into the terminal. Turn the capture screw fully clockwise to secure the conductor.

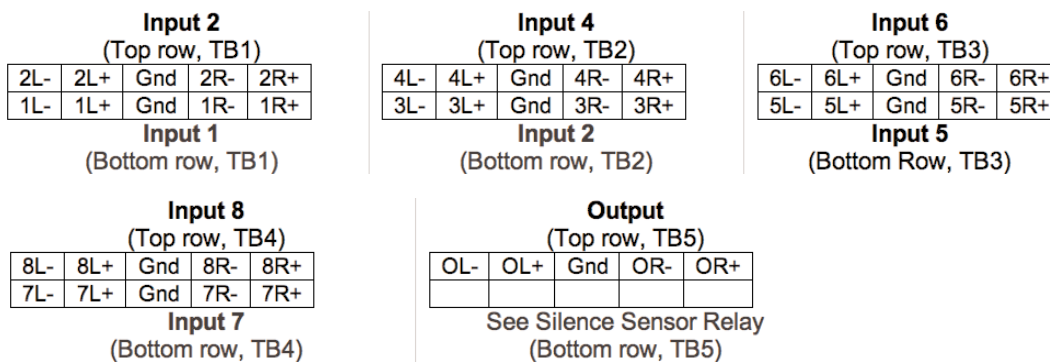

Input sources that are NOT selected are terminated with a 10K ohm resistor. If you do not require this load applied to the deselected sources, they may be removed from each channel. Each channel has a pair of resistors. Removal information: Channel 1 = R6 & R14. Channel 2 = R7 & R15. Channel 3, R8 & R16. Channel 4 = R9 & R17. Channel 5 = R10 & R18. Channel 6 = R11 & RR19. Channel 7 = R12 & R20. Channel 8 = R13 & R21. If the SS 8.1 MLR is to be used for applications other than switching analog audio, the Silence Sensor and ACT detection circuit should be disabled. To disable, remove RP9 from its socket.

PIP (GPI)/Remote Control Inputs

The SS 8.1 MLR has eight status inputs that may be configured for PIP (“triggers”) or remote control operation and accept momentary contact closures (sustained, if break before make); open collector or TTL/CMOS input logic levels.

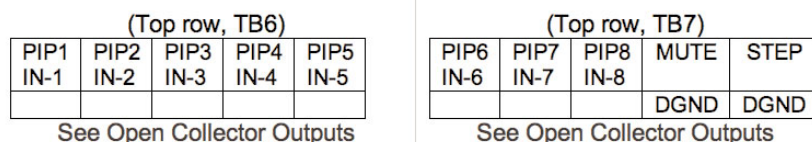

The PIP/remote control operation mode is set by the SW11-7 Dip-switch, when SW11-7 is OFF the unit is in remote control mode and when SW11-7 in ON the unit is in PIP mode. The PIP/remote control connections to the switcher are found on the top rows of the connectors TB6 and TB7. Each channel may be selected by a momentary contact to ground (DGND) located on the bottom TB7 connector. Each channel is pulled high (5-volts) through a 22K resistor.

WEBSITE:

Visit our web site for product updates and additional information.

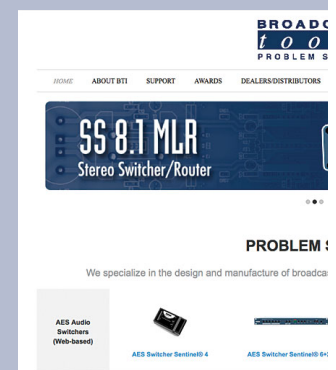

INSTALLATION

The PIP/remote control operation mode is set by the SW11-7 Dip-switch, when SW11-7 is OFF the unit is in remote control mode and when SW11-7 is ON the unit is in PIP mode. The PIP/remote control connections to the switcher are found on the top rows of the connectors TB6 and TB7. Each channel may be selected by a momentary contact to ground (DGND) located on the bottom TB7 connector. Each channel is pulled high (5-volts) through a 22K resistor.

In remote control mode the inputs are triggered by momentary closure to (pulsing) to ground (low.) For example, pulsing the “MUTE” input to ground would turn off the output of the SS 8.1 MLR until a front panel source switch is pressed, a different remote control input is activated, the unit is powered up and/or a serial command is received from a PC or other serial device.

Pulsing the “STEP” input to ground will step the unit one source for each low to high transition on this input. Automatic timed sequencing may be accomplished by holding the step input low. The unit will now step to each source at a user programmable rate from 1 to 99 seconds (10 seconds by default). The last step channel is user programmable and is set to 8 by default. This feature may be used to sequence through multiple station air monitor signals for a program on-hold feed.

The SS 8.1 MLR is also capable of being used for EAS audio insertion. This feature is enabled by setting the EAS controlled input channel via RS232 to the desired audio input channel (see the Serial Operation section of this manual for more information.) Once an input channel has been designated the SS 8.1 MLR will automatically switch to that input for the duration of a sustained closure to ground on the designated PIP/remote control input.

Open Collector Outputs

The SS 8.1 MLR has eight open collector outputs that are used to indicate channel selection status. OC1 indicates for Input 1, OC2 indicates for Input 2, etc. The status open collector (OCx) output for the selected channel will go low providing a return for an LED indicator, TTL/CMOS logic or relay. External pull-up resistors may be required in some installations, voltages must be limited to 6 VDC at 600 mA.

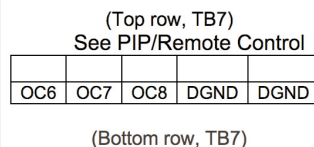
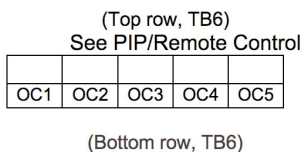

CAUTION!

Installation of the SS 8.1 MLR in high RF environments should be performed with care. The station ground should be connected to the designated chassis ground terminal using a 20 to 24-gauge wire.



NOTE:

For wiring information, refer to the grids in this section of the manual, the silk-screen text on the rear panel of the product or the fractional schematic in the appendix.

WEBSITE:

Visit our web site for product updates and additional information.

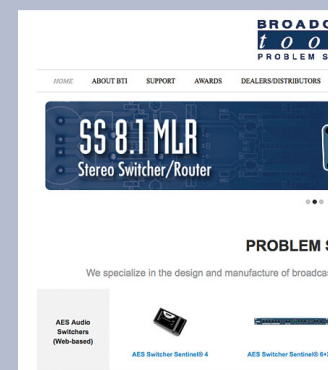

Configuration Jumper Setup

JP1: Disabled = Front panel enable switch defeated.

Enabled= Front panel ENABLE push button active.

NOTE: The enable push button must be held closed to operate any of the other front panel push buttons and isn't associated with any of the remote control functions.

Configuration Dip-switch Setup

Follow the tables below for SW11 dip-switch configuration options.

Unit ID	SW11-1	SW11-2	SW11-3
ID 0 *	OFF	OFF	OFF
ID 1	ON	OFF	OFF
ID 2	OFF	ON	OFF
ID 3	ON	ON	OFF
ID 4	OFF	OFF	ON
ID 5	ON	OFF	ON
ID 6	OFF	ON	ON
ID 7	ON	ON	ON

Baud Rate	SW11-4	SW11-5
2400	ON	OFF
9600 *	OFF	OFF
19200	OFF	ON
38400	ON	ON

Power Up	SW11-6
User selected	ON
Last source selected *	OFF

Note: To select an input at power-up with SW11-6 ON, hold down the push-button for the desired input channel or mute until the front panel LED's flash.

Operation Mode	SW11-7
Remote Control*	OFF
PIP	ON

Remote control operation mode: Pulse 1-IN to select channel 1, pulse IN-2 to select channel 2, pulse IN-3 to select channel 3, pulse IN-8 to select input 8 etc., pulse the "M-IN" (mute) pin to turn off all channels.

PIP mode: activity on any of the PIP inputs will generate a serial status string in the PIP format. For use with automation software.

Note: After changing any dip-switch, please repower the unit.

Note: * Denotes factory setting.

SERIAL OPERATION

RS-232 Control

Connect one end of the modular cable to the RJ11 jack on the rear panel of the product and the other end to the RJ11 to the jack on the “S9” 9-pin female D-sub adapter. Connect the 9-pin female D-sub “S9” adapter to the COM port of the controlling PC. Note: An optional USB to RS-232 adapter cable may be required if your PC isn’t equipped with a RS-232 COM port. The default protocol is as follows: 9600, N, 8, 1 (other baud rates are user selectable). Select the desired unit ID address for each unit using the configure Dip-switches, zero is the factory default setting. Never duplicate addresses.

RJ-11 Adapter Pin	DB-9 D-SUB Pin #	SS 8.1 MLR (Product Point of view)
4	3	RS-232 Receive
3	2	RS-232 Transmit
2	5	Ground

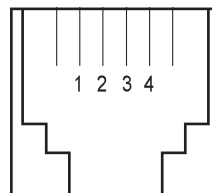

Modular Jack Pin Numbers

Serial Commands

The switcher may be controlled and monitored by burst serial strings or by the embedded menu.

Where the < * > Denotes start of string character
 < u > Unit ID (address, 0 through 7)
 < ii > Input channel (01, 02, 03, 04, 05, 06, 07, 08)
 < o > Output channel (1)

- *u ii - Turn on input ii
- *uMA - Mute output
- *uMM - Go to setup menu, see menu operation section of the manual for more information.

Examples: *008 This string would turn on channel 8 for unit ID 0.
 *0MM Accesses the setup menu. (NOTE: The setup menu times out after 60 seconds of keyboard inactivity).

- *POLL Returns unit ID address in appropriate time slot.
 - *uSL Sends audio status for all inputs: SuLo,x,x,x,x,x,x,x,x<CR><LF>
 - *uSP ii Sends PIP status for input ii : SuP, ii ,x
 - *uSPA Sends PIP status for all inputs: SuP,A,x,x,x,x,x,x,x,x <CR><LF>
 - *uSS Sends status of silence sensor: SuS,a<CR><LF>
- a = 1 = not silent, 0 is silent

WEBSITE:
 Visit our web site for product updates and additional information.

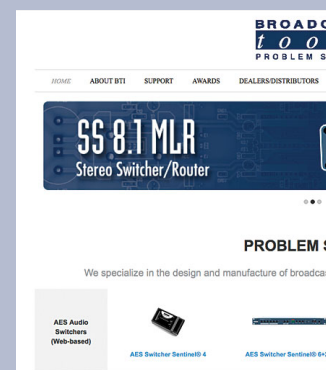

- *uU Sends unit firmware version: <name><version><lf>
- *uY Display configuration.
- *uZx Echo character x to serial control port - for debugging command strings

- *uCEx Enable error and good responses if x = Y (default N)
- *uCDEF Reset to factory defaults.
- *uCLx Lock front panel: x = L (Lock) x = U (Unlock)
- *uCIIttt Sets PIP minimum pulse length ttt: 000 - 255 => off to 2.55 seconds.

- *uCPS Power up audio state: save power up state now

- *uCSLx Sets silence sensor detection threshold to Off, -20, -25, -30 dB (0,1,2,3)
- *uCSAtttt Sets silence sensor acquire delay to tttt seconds (0, 2-255)
- *uCSBtttt Sets silence sensor restore delay to tttt seconds (0, 2-255)

- *uCSCtt Sets step interval in seconds 1-99 seconds.
- *uCSSt Sets last step channel 1-8 (0 disables step feature.)

- *uCSEi Sets EAS controlled input channel (i) to 1-8 or 0 for off. This allows you to assign one input channel that will be switched to with sustained closure to ground on its remote control input from an EAS encoder for EAS audio insertion with the SS 8.1 MLR.
- *uDxx Delay xx seconds before processing next command.
- *uDLxxx Delay xxx seconds before processing next command.

Menu Operation

```
Broadcast Tools(R) SS 8.1 MLR, v1.2 - Setup Menu
1 - Set PIP Minimum Hold Time(0 - 2.55 sec) - Now:0.05
2 - Set Silence Sense Acquire Delay (sec) - Now: 10
3 - Set Silence Sense Restore Delay (sec) - Now: 2
4 - Set Silence Sense Threshold - Now:-25 dBu
5 - Set Stepping Interval (sec 1-99) - Now: 10
6 - Set Last Step Channel - Now: 8
7 - Lock/Unlock Front Panel - Now:UNLOCKED
8 - Set EAS Controlled Input - Now: Off

S - Turn ON audio input
M - Turn OFF audio

V - Save Audio State for Power Up
C - Show Configuration and Status
F - Set Factory Defaults

Audio Status:Silent - Channel 1

Enter Selection, or Q to quit:
```

To select a menu function, simply enter the letter on the left side of the menu and wait for the prompt. Example: Type the letter “S” Response: Enter Input Channel: Entering a 1 would select channel 1.

SPECIFICATIONS

Inputs/Outputs:	Any input level and impedance can be used. Inputs may be balanced or unbalanced. Output levels, impedance, distortion, noise and balancing will match that of the selected input.
Switching Method:	Passive. Mechanical latching sealed relays utilizing 2-form-C bifurcated-crossbar silver alloy with gold overlay contacts.
Logic:	Flash microprocessor with non-volatile memory.
Operation Control:	Front Panel - Momentary switches. Remote - Momentary or sustained compatible with 5 volts CMOS/TTL logic, open collector or contact closures to ground. Serial - Multi-drop RS-232, 2400, 9600, 19200, 38400 8,N,1.
Status:	Front Panel - LED Indicators. Remote - Eight open collector status outputs rated at 6 vdc @ 100ma each. One SPDT and one SPST silence sense relay. 1-amp 30 vdc maximum.
Interfacing:	I/O and Remote control - Rear panel pluggable screw terminals. Mating connectors supplied. RS-232 - (RJ-11) Reversed modular cable/female "S9" 9-pin D-Sub adapter supplied. Refer to the fractional schematic and/or text on the rear panel for connection details.
Power Requirements:	7.5 to 12 VDC@500 ma. CE certified universal switching 9 VDC adapter with domestic AC connector supplied. International connectors optional.
Physical Dimensions:	8.50" x 7.10" x 1.576" (WDH)
Weight:	3.0 lb.
Shipping Weight:	4.0 lb.
Options:	RA-1 rack shelf, holds two units (1-RU) / Filler panels supplied.

The SS 8.1 MLR Conforms to the same CE certification as the older SS 8.1 II

WEBSITE:

Visit our web site for product updates and additional information.

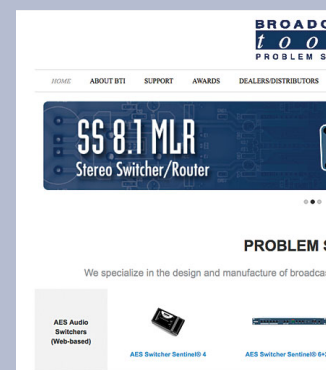

LIMITED WARRANTY

The term "Buyer" as used in this document refers to and includes both (but only) (a) any person or entity who acquires such an item for the purpose of resale to others (i.e., a dealer or distributor of an item), and (b) the first person or entity who acquires such an item for such person's or entity's own use.

Broadcast Tools warrants to each Buyer of any item manufactured by Broadcast Tools that the item will be free from defects in materials and workmanship at the time it is shipped by Broadcast Tools if the item is properly installed, used and maintained.

EXCLUSIVE REMEDIES

If Broadcast Tools is notified, in writing, of a failure of any item manufactured by Broadcast Tools to conform to the foregoing Limited Warranty within one (1) year following the date of the Buyer's acquisition of the item, and if the item is returned to Broadcast Tools in accordance with Broadcast Tools' instructions for confirmation by inspection of the defect (which at Broadcast Tools' election may include, without limitation, a requirement that the Buyer first obtain a Return Authorization number from Broadcast Tools, that the Buyer furnish proof of purchase in the form of an invoice and/or receipt, and that the Buyer prepay all freight charges associated with any return of the item to Broadcast Tools using such freight service as Broadcast Tools reasonably may specify), Broadcast Tools will repair or replace the defective item, or will refund the purchase price paid by the Buyer for the item. Broadcast Tools shall have the exclusive right to choose between these alternative remedies.

NO OTHER WARRANTIES OR REMEDIES

TO THE MAXIMUM EXTENT PERMITTED BY APPLICABLE LAW, BROADCAST TOOLS AND ITS SUPPLIERS DISCLAIM ALL OTHER WARRANTIES, EITHER EXPRESS OR IMPLIED, INCLUDING BUT NOT LIMITED TO IMPLIED WARRANTIES OF MERCHANTABILITY OR FITNESS FOR A PARTICULAR PURPOSE; AND THE FOREGOING ALTERNATIVE REMEDIES SHALL BE EXCLUSIVE OF ALL OTHER REMEDIES. THIS LIMITED WARRANTY GIVES YOU SPECIFIC LEGAL RIGHTS. YOU MAY HAVE OTHER RIGHTS, WHICH VARY FROM STATE/JURISDICTION TO STATE/JURISDICTION.

NO LIABILITY FOR CONSEQUENTIAL DAMAGES

TO THE MAXIMUM EXTENT PERMITTED BY APPLICABLE LAW, NEITHER BROADCAST TOOLS NOR ANY OF ITS SUPPLIERS SHALL HAVE ANY LIABILITY FOR ANY SPECIAL, INCIDENTAL, INDIRECT, CONSEQUENTIAL OR PUNITIVE DAMAGES WHATSOEVER (INCLUDING, WITHOUT LIMITATION, ANY DAMAGES FOR LOST PROFITS, BUSINESS INTERRUPTION, LOSS OF DATA OR INFORMATION, COST OF CAPITAL, CLAIMS OF CUSTOMERS, OR ANY OTHER PECUNIARY LOSS) ARISING OUT OF THE USE OF OR THE INABILITY TO USE ANY ITEM SUPPLIED BY BROADCAST TOOLS, EVEN IF BROADCAST TOOLS HAS BEEN ADVISED OF THE POSSIBILITY OF SUCH DAMAGES HAVE ANY LIABILITY FOR ANY SPECIAL, INCIDENTAL, CONSEQUENTIAL, EXEMPLARY OR PUNITIVE DAMAGES. THIS LIMITATION OF LIABILITY APPLIES WHETHER A CLAIM IS ONE ALLEGING BREACH OF A CONTRACT OR WARRANTY, NEGLIGENCE OR OTHER TORT, FOR THE VIOLATION OF ANY STATUTORY DUTY, THE FAILURE OF ANY LIMITED OR EXCLUSIVE REMEDY TO ACHIEVE ITS ESSENTIAL PURPOSE, OR ANY OTHER CLAIM OF ANY NATURE. BECAUSE SOME STATES AND JURISDICTIONS DO NOT ALLOW THE EXCLUSION OR LIMITATION OF LIABILITY FOR INCIDENTAL OR CONSEQUENTIAL DAMAGES, THIS LIMITATION MAY NOT APPLY TO YOU.

Broadcast Tools, Inc.

131 State Street
Sedro-Woolley, WA 98284 • USA

360.854.9559 **voice** • 866.783.1742 **fax**
support@broadcasttools.com **e-mail**
www.broadcasttools.com **website**

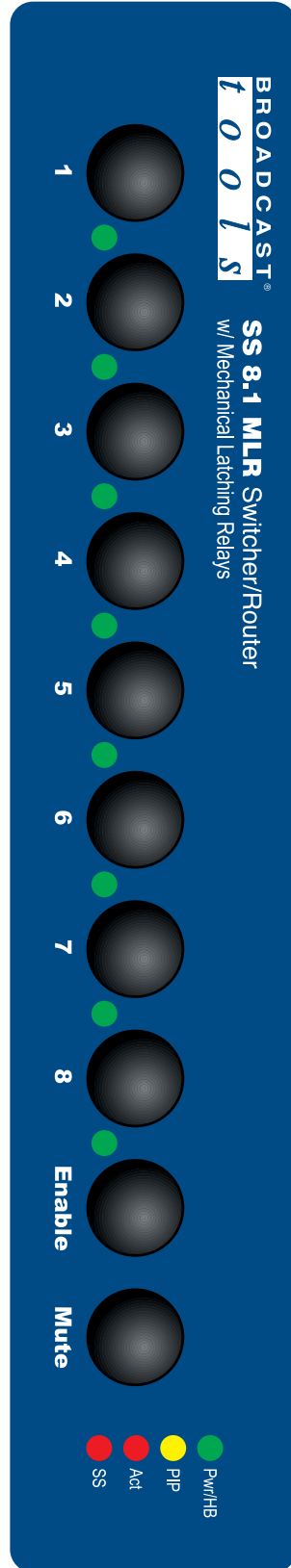
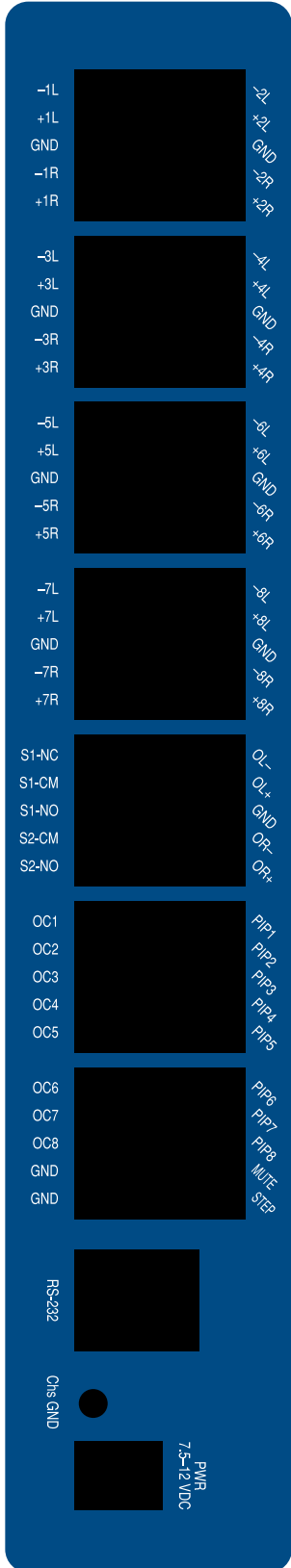

SS 8.1 MLR Component Layout

Component Layout

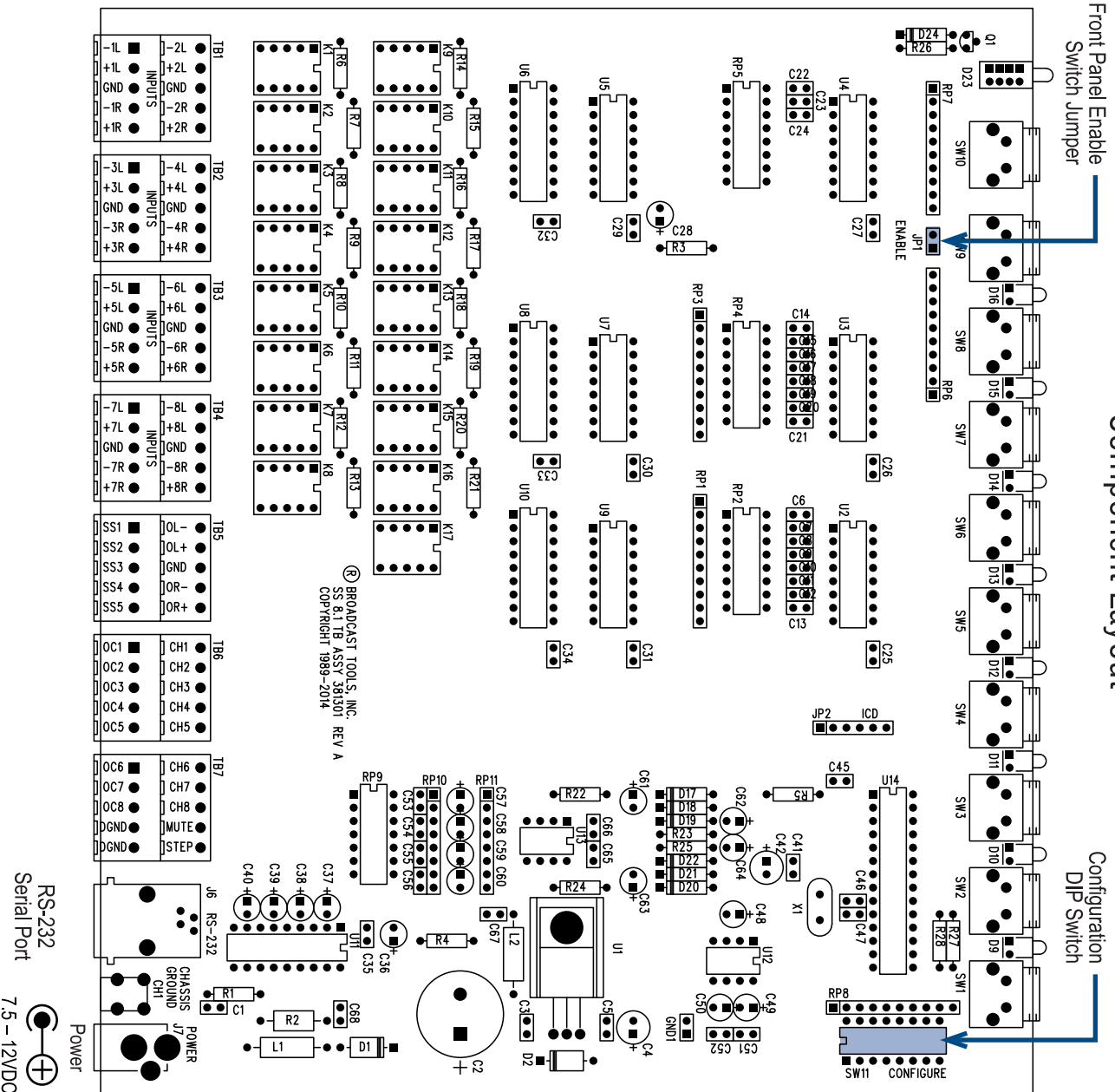

FRACTIONAL SCHEMATIC

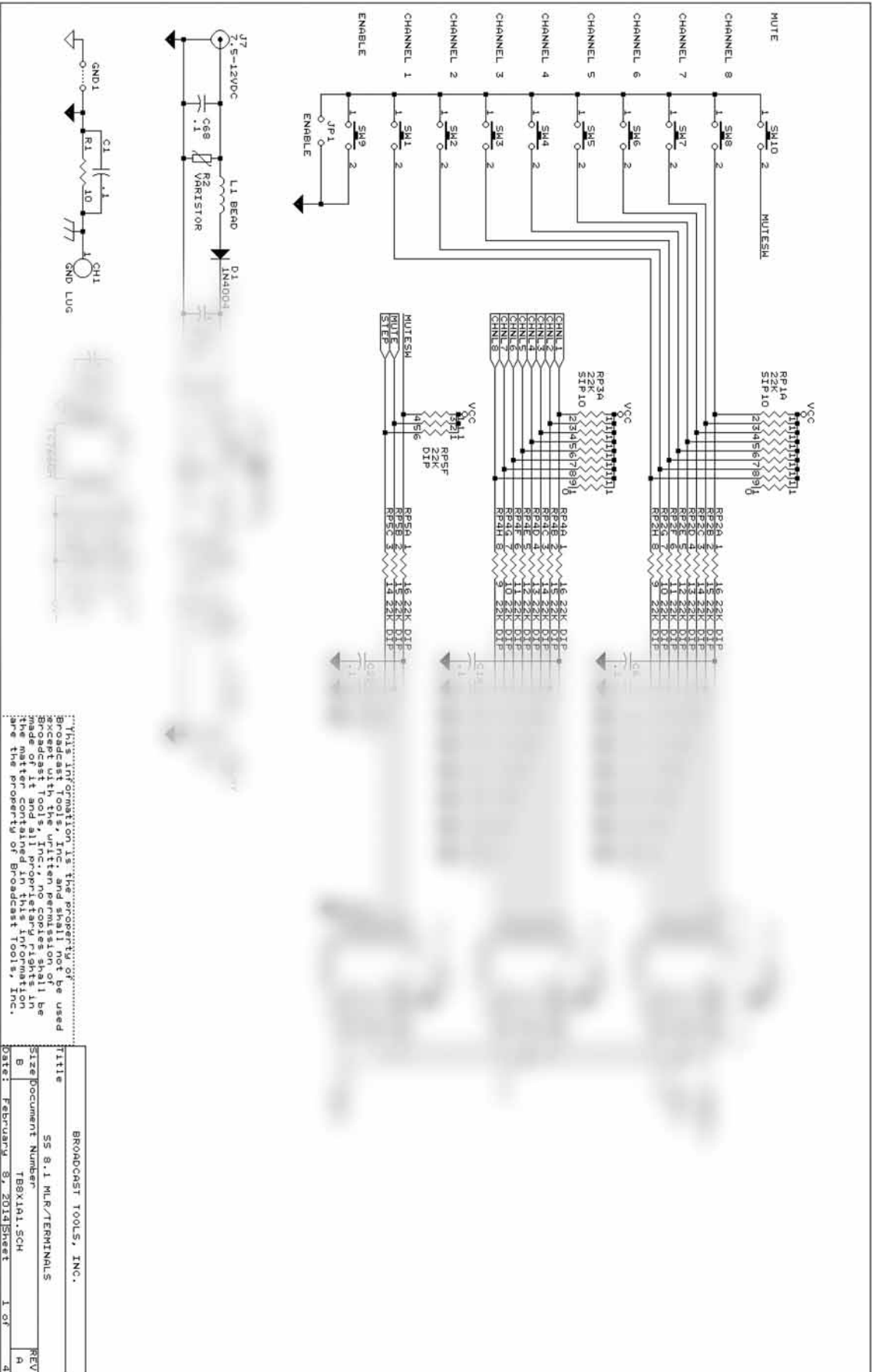

This information is the property of Broadcast Tools, Inc. and is not to be used without the written permission of Broadcast Tools, Inc. No copies shall be made of it and all proprietary rights in it are the property of Broadcast Tools, Inc.

BROADCAST TOOLS, INC.	
Title	SS 8.1 MLR/TERMINALS
Size/Document Number	188X1A1.SCH
REV	A
Date:	February 07, 2014 Sheet 1 of 4

FRACTIONAL SCHEMATIC

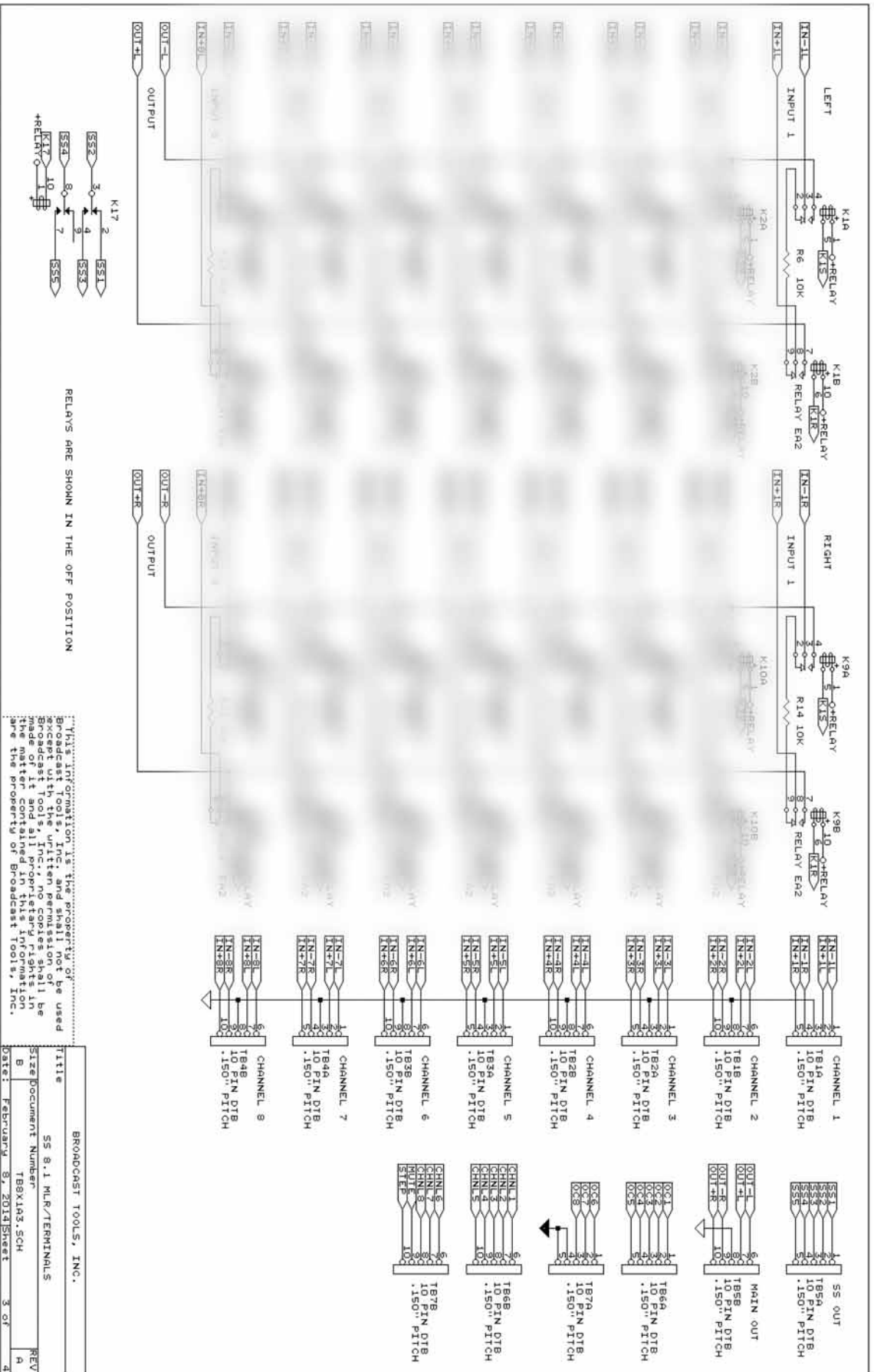

BROADCAST TOOLS, INC.	
Title	SS 8.1 MLR/TERMINALS
Size/Document Number	TB8X1A5.SCH
REV	A
Date:	February 8, 2014
Sheet	3 of 4

