

BROADCAST[®] tools^{INC}

PROBLEM SOLVED

Installation and Operation Manual

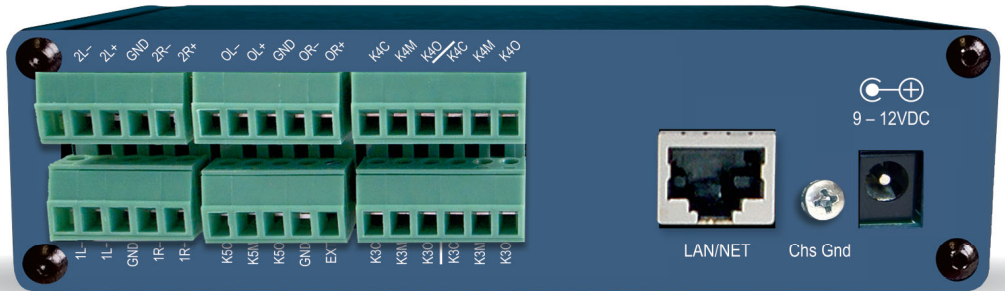
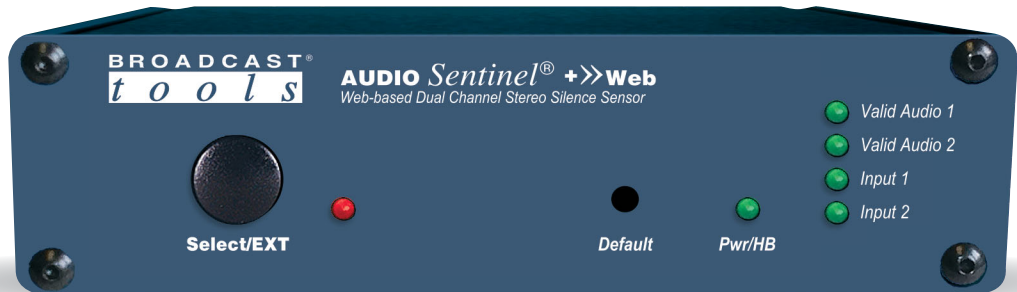

Audio Sentinel[®]+>> Web *Web-enabled two channel stereo silence monitor*

Manual update: Manual update: 10/29/20

For firmware versions equal to or greater than ASX_V2.02 / ASW_V1.37 / ASP_1.03

If you need a firmware upgrade, contact Broadcast Tools[®]

No part of this document may be reproduced or distributed without permission.
ALL SPECIFICATIONS AND FEATURES FOR THIS PRODUCT ARE SUBJECT TO
CHANGE WITHOUT NOTICE

NOTE: We recommend the use of Chrome, Firefox or Safari as your browser.

Due to the dynamic nature of product design, the information contained in this document is subject to change without notice. Broadcast Tools, Inc., assumes no responsibility for errors and/or omissions contained in this document. Revisions of this information or new editions may be issued to incorporate such changes.

*Broadcast Tools[®] is a registered trademark of Broadcast Tools, Inc.
All Sentinel[®] labeled products are registered trademarks of Broadcast Tools, Inc.
Copyright[®] 1989 - 2020 by Broadcast Tools, Inc. All rights reserved.
No part of this document may be reproduced or distributed without permission.*

Visit www.broadcasttools.com for important product update information.

Table of Contents

| Section Title | Page # |
|---|----------|
| Introduction | 3 |
| Safety Information | 3 |
| Who to Contact for Help | 3 |
| Product Overview | 4 |
| Inspection | 5 |
| Installation | 5 |
| Surge Protection | 5 |
| UPS Standby Power System | 5 |
| 9-12 VDC POWER connector | 5 |
| LED Indicators | 6 |
| Front Panel Controls | 6 |
| Audio Input Connections | 6 |
| Audio Output Connections | 6 |
| Remote Control Connections | 7 |
| LAN / NET Jack | 7 |
| Chassis ground | 7 |
| Manual Operation and Indicators | 8 |
| Ethernet “Quick Start” Guide | 9 |
| Opening the LOGIN Web Page | 12 |
| Web Setup/Operation | 13 |
| “Login” Web Page | 13 |
| “Monitor/Control” Web Page | 14 |
| “User Setup” Web Page | 16 |
| “Silence Sensor Setup” Web Page | 17 |
| “Email/Network Setup” Web Page | 20 |
| Restoring Network Factory Defaults | 21 |
| “Show Log” Web Page | 25 |
| “About” Web Page | 26 |
| Specifications | 27 |
| Warranty | 28 |
| Declaration of Conformity | 29 |
| Functional Diagram | Appendix |
| Connector Layout | Appendix |
| Front and Rear Panel silkscreen views | Appendix |
| Fractional Schematic | Appendix |

WEBSITE:
Visit our web site for product updates and additional information.

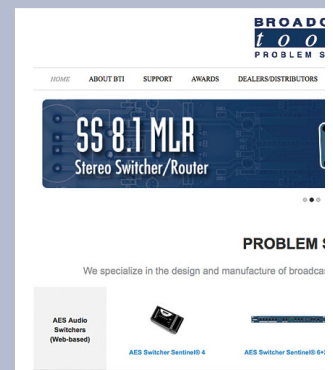

INTRODUCTION

Thank you for your purchase of a Broadcast Tools® Audio Sentinel®+» Web Web-enabled two channel stereo silence monitor/audio switcher (referred to as the Audio Sentinel® throughout this manual). We're confident that this product will give you many years of dependable service. This manual is intended to give you all the information needed to install and operate the Broadcast Tools® Audio Sentinel®.

SAFETY INFORMATION

Only qualified technical personnel should install the Audio Sentinel®+» Web. Any attempt to install this device by a person who is not technically qualified could result in a hazardous condition to the installer or other personnel or damage to the Audio Sentinel®+» Web or other equipment. Please ensure that proper safety precautions have been taken before installing this device. If you are unfamiliar with this type of equipment, please contact a properly qualified engineer to handle the installation and setup of the Audio Sentinel®+» Web.

WHO TO CONTACT FOR HELP

If you have any questions regarding your product or you need assistance, please contact your distributor from whom you purchased this equipment. If you would like more information about BROADCAST TOOLS® products, you may reach us at:

Broadcast Tools, Inc.

131 State Street
Sedro-Woolley, WA 98284-1503 USA
Voice: 360.854.9559
Fax: 866.783.1742

Internet Home Page: www.broadcasttools.com
E-mail: support@broadcasttools.com

**THANK YOU FOR CHOOSING
BROADCAST TOOLS® BRAND PRODUCTS!**

Broadcast Tools is a Veteran Owned Business



Designed, Assembled and Supported in WA State, USA



CAUTION!

Broadcast Tools® Products, as with any electronic device, can fail without warning. Do not use this product in applications where a life threatening condition could result due to failure.



NOTE:

This manual should be read thoroughly before installation and operation.

WEBSITE:

Visit our web site for product updates and additional information.

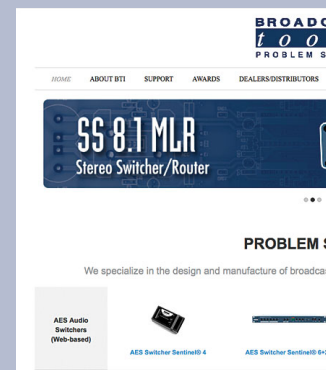

Product Overview

The Audio Sentinel®+»Web is a web-enabled two channel stereo silence monitor combined with a transparent, integrated stereo audio switcher. Audio Sentinel®+»Web is designed to monitor two balanced or unbalanced independent stereo analog audio sources, one primary, the other back-up. When silence is detected on the primary input it can automatically switch to the back-up analog audio. The Audio Sentinel®+»Web may also be configured for independent dual-stereo non-switching applications. The Audio Sentinel®+»Web can be controlled and monitored locally and/or remotely over any IP network, including private networks, IP-based industrial control networks, and the Internet. Users can operate the product using a web browser or web-enabled mobile device. Email notification may be configured to alert up to eight recipients when silence is detected. SMTP username and passwords using Base64 authentication are supported. The user may also enable a sound effect to play on their PC speaker when an alarm is generated. Logging of system status, along with the site ID may be emailed in time spans from once an hour to once a day. One SPDT relay is supplied to indicate which input channel is feeding the output, while two additional DPDT relays can be independently configured to provide additional notification. SNMP traps and SET/GET to allow multiple units to be monitored and controlled with SMNP management software.

Features/Benefits

- Built-in web server provides simple, web based notification, monitoring, configuration, control.
- Internal silence sensor with front panel activity and alarm LED indicators.
- Front panel, remote, and web-based switcher controls.
- Silence trip level detection from -24dB to -35dB in 1 dB steps for each stereo channel.
- Precise alarm time delay from 0(OFF) to 65535 seconds (18 hours, 12 min and 15 sec's). in one-second increments for each channel.
- Alarm restore time delay from 0(OFF) to 65535 seconds (18 hours, 12 min and 15 sec's). in one-second increments for each channel.
- Email notification may be configured to alert up to EIGHT recipients when alarms are detected.
- Email logging of system status, along with the site ID may be emailed in time spans from once an hour to once a day.
- Support for Base64 SMTP authentication.
- Removable euroblock-style screw terminal connectors simplify wiring and service. Mating plugs are supplied.
- Fully RFI proofed.
- Surge protected internal power supply, 9VDC universal AC input power supply with domestic connectors supplied. International AC connectors optional.
- Up to three units may be mounted on the optional RA-1 rack shelf. Desktop and wall mounting is also possible.

WEBSITE:

Visit our web site for product updates and additional information.

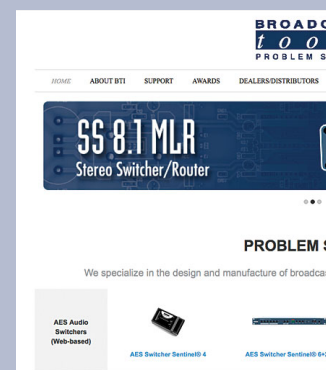

OVERVIEW

Inspection

Please examine your Audio Sentinel® carefully for any damage that may have been sustained during shipping. If any damage is noted, please notify the shipper immediately and retain the packaging for inspection by the shipper. The package should contain the Audio Sentinel®, a 7-foot BLUE straight-through CAT 5 cable, a 7-foot GRAY crossover CAT 5 cable and a 9 VDC @ 660 milliamp wall power supply. Manuals may be downloaded from our web site.

Installation

Surge Protection

The Audio Sentinel® has built-in resistance to voltage changes; we recommend that you use a power surge protector or line conditioner on the incoming AC line. Lightning strikes and/or other high voltage surges may damage your Audio Sentinel® and connected equipment if it is not properly protected. For lightning protection devices, check out www.polyphaser.com and www.itwlinx.com.

UPS Standby Power System

We recommend that you connect your Audio Sentinel® to a UPS system. A UPS helps minimize the risk to the Audio Sentinel® and provides AC power during a power outage.

NOTE: Signal bypass is provided by internal relays that will passively route the input one signal to the output in the event of power loss.

POWER, 9-12 VDC connector

Connect the 2.1mm barrel type power connector into the unit and the 9 to 12 VDC universal switching power supply with domestic AC connector into a 120 Vac 50-60 Hz power source.

NOTE: Never use any type of power supply other than the specified/supplied power supply.



Installation of the Audio Sentinel® in high RF environments should be performed with care. The station ground should be connected to the "Chs Gnd" chassis ground screw.

WEBSITE:

Visit our web site for product updates and additional information.

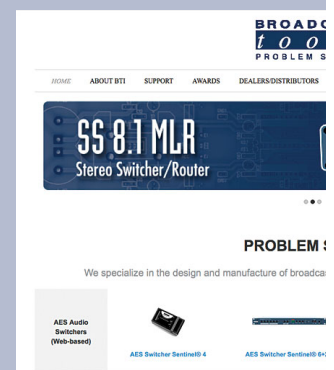

LED Indicators

- “Pwr/HB” LED: Illuminates when power is applied and flashes to indicate microprocessor operation. (Green)
- “Select/EXT” LED: Lit when EXTERNAL input control is active. (Red)
- “Valid Audio 1” LED: Lit when input 1 audio is above threshold. (Green)
- “Valid Audio 2” LED: Lit when input 2 audio is above threshold. (Green)
- “Input 1” LED: Lit when Input 1 is routed to the output. (Green)
- “Input 2” LED: Lit when Input 2 is routed to the output. (Green)

Front Panel Controls

The “Select/EXT” push button is a multifunction button that is connected to the EXT remote control input. The button’s function is determined by the “Ext-Input” setting on the Silence Sensor Setup page. See the Manual Operation section of this manual for more information.

Audio Input Connections

Connect your primary audio source to Input 1 and your back audio source to Input 2. For unbalanced inputs, connected the high side of the source to the (+) positive input and the shield along with a jumper between the “-” input and GND terminals. Single (monaural) input sources should have their left and right inputs connected in parallel. Proper phasing must be observed.

| Input 1 (Top row, TB1) | | | | |
|------------------------------|-----|-----|-----|-----|
| 2L- | 2L+ | Gnd | 2R- | 2R+ |
| 1L- | 1L+ | Gnd | 1R- | 1R+ |
| Input 2 (Bottom row, TB1) | | | | |

Audio Output Connections

Connect the output device/load to the terminals labeled “OL-/+ CM and OR-/+ CM. For unbalanced loads, use the “+” and GND terminals only. Shields should be tied to the “GND” terminals.

ⁿ NOTE: The output can be left disconnected if switching is not required.

| Output (Top row, TB2) | | | | |
|--|-----|-----|-----|-----|
| OL- | OL+ | Gnd | OR- | OR+ |
| | | | | |
| See Remote Control Connections (Bottom Row, TB3) | | | | |

WEBSITE:

Visit our web site for product updates and additional information.

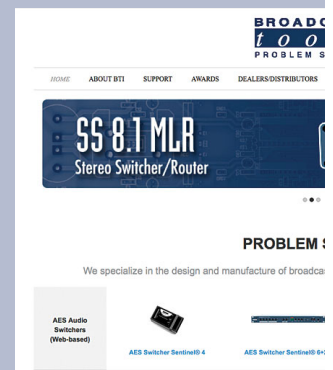

INSTALLATION

Remote Control Connections

The Audio Sentinel® has one remote control input labelled “EXT” (external) which can be configured for either toggle or sustained closure control. In toggle mode each time this input is pulled to ground, the unit toggles between channels one and two. In sustained mode the EXT input will immediately trigger and switch to the backup source until released. This may be used to interface with a STL or satellite squelch relay. The EXT remote control input is pulled high (5-volts) internally through a 10K resistor.

(Top row, TB2)

| | | | | |
|------|------|------|-----|--------------------------|
| | | | | |
| K5NC | K5CM | K5NO | GND | EXT (EXternal) |

(Bottom Row, TB2)

The Audio Sentinel® has three relay contact closure remote control outputs. The SPDT relay K5 is used to represent the status of the internal audio switcher. When input channel ONE is selected (or power is removed from the unit) the NO contact is open, while the NC contact is closed with respect to the CM contact. When input channel TWO is selected the NO contact is closed, while the NC contact is open with respect to the CM contact.

K3 and K4, are available for user configurable notification. The operation of the K3 & K4 DPDT relays is determined by the configuration assigned on the “Silence Sensor Setup” page.

(TB3 Top)

| | | | | | |
|--------|--------|--------|--------|--------|--------|
| K4A NC | K4A CM | K4A NO | K4B NC | K4B CM | K4B NO |
| K3A NC | K3A CM | K3A NO | K3B NC | K3B CM | K3B NO |

(TB3 Bottom)

LAN / NET Jack

RJ45 Ethernet jack for 10/100baseT LAN/WAN connection.

Chassis Ground (Chs Gnd)

Tie to station ground system.

WEBSITE:

Visit our web site for product updates and additional information.

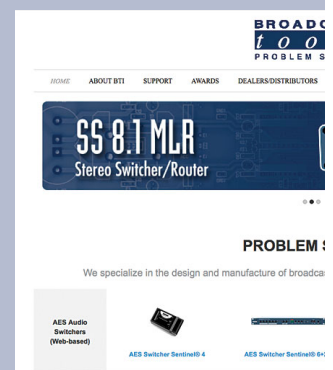

INSTALLATION

Manual Operation and Indicators

The Audio Sentinel® can be controlled from a web browser, front panel controls, and/or remote control connections. The slow blinking front panel “PWR/Heartbeat” LED indicates valid power and proper operation. The front panel is also equipped with two LED’s (Valid Audio x) to indicate when valid stereo or dual-monaural audio is detected for each channel.

Two additional LED’s (channel x) indicate what channel is active (x indicates either channel one or two).

The “EXT/Select” push button is in parallel with the rear panel terminal. The front panel LED indicates when activated. The EXT/Select control’s function is user configurable for either sustained or toggle mode operation.

NOTE: Sustained mode operates in either manual or automatic mode.

Sustained mode is normally used with STL or satellite receiver systems with the input tied to the receivers squelch relay. When the receiver fails, the squelch relay closes and forces the Audio Sentinel to switch to channel two. When the relay opens, the unit returns to channel one.

When the toggle mode is selected, each time this input is pulled to ground, the unit toggles between channels one and two. **NOTE: The unit MUST be in MANUAL mode.** See Silence Sensor Setup for more information.

Factory defaults may be restored by depressing the recessed front panel “Default” push button for five seconds while powering up the unit. The PWR/HB led will rapidly blink two to three times when loaded.

WEBSITE:

Visit our web site for product updates and additional information.

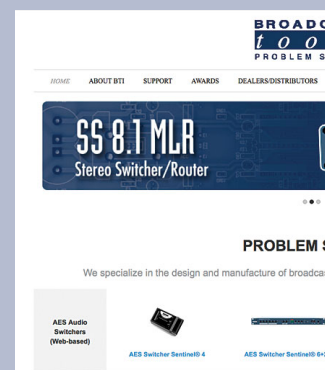

Ethernet “Quick Start” Guide

CAUTION! NEVER DOWNLOAD FIRMWARE UPDATES OR CHANGES TO THE XPORT WEBSERVER UNLESS INSTRUCTED TO DO SO BY BROADCAST TOOLS®. DOING SO DELETES ALL SOFTWARE AND VOIDS ALL WARRANTIES FROM BROADCAST TOOLS, INC.

CAUTION! If you are not familiar with Ethernet enabled equipment, it may be useful to contact your IT department, network administrator or network consultant for assistance. Assigning an IP address already in use by another device may cause problems with your network!

Instructions for changing the IP address of the computer that will be used for the configuration of this product are given here. Note that these instructions are specifically for computers with the Windows XP operating system. For setup using other operating systems, refer to the appropriate OS user’s manual.

Step 1: Open the control panel by clicking on the start menu, click on settings, then click on Control Panel. (Note that the control panel shown is in “Classic View”. If control panel is in “Category View” select the “Classic View” option before proceeding.)

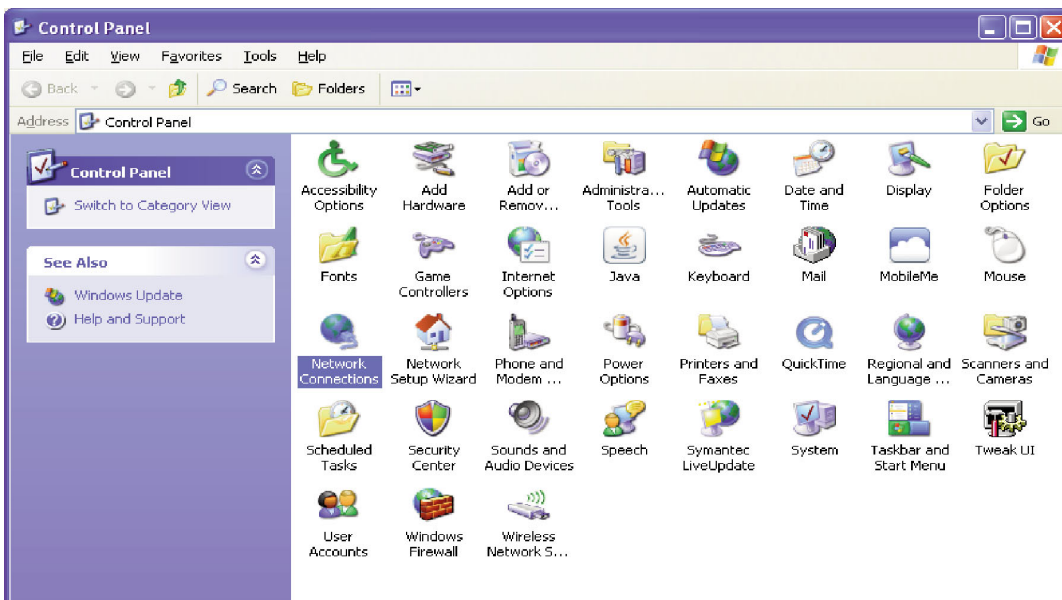

WEBSITE:

Visit our web site for product updates and additional information.

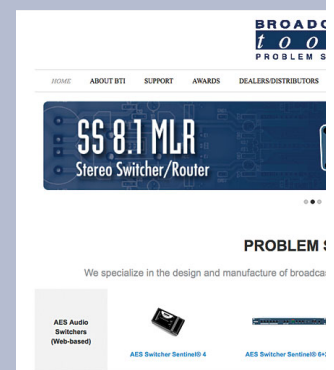

Step 2: Double click on the icon labeled Network Connections. The following menu will pop up.

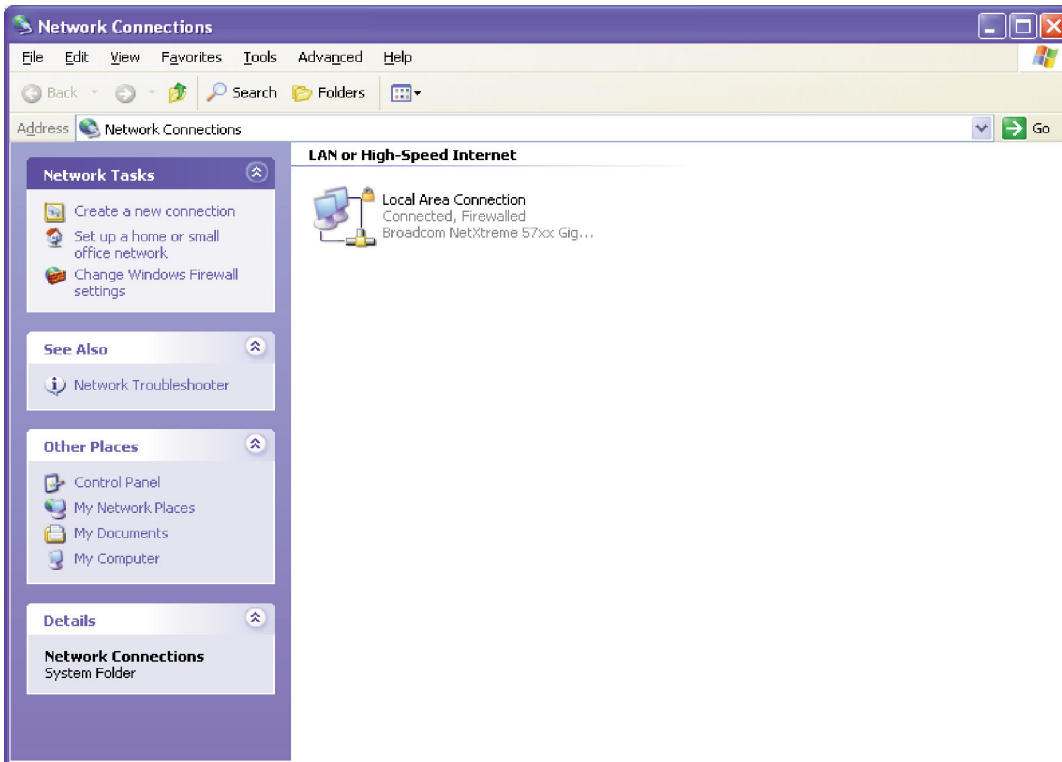

Step 3: Right click on the icon labeled Local Area Connection. Another menu will appear. Select the option at the bottom of the menu labeled Properties. The Local Area Connection Properties window will appear.

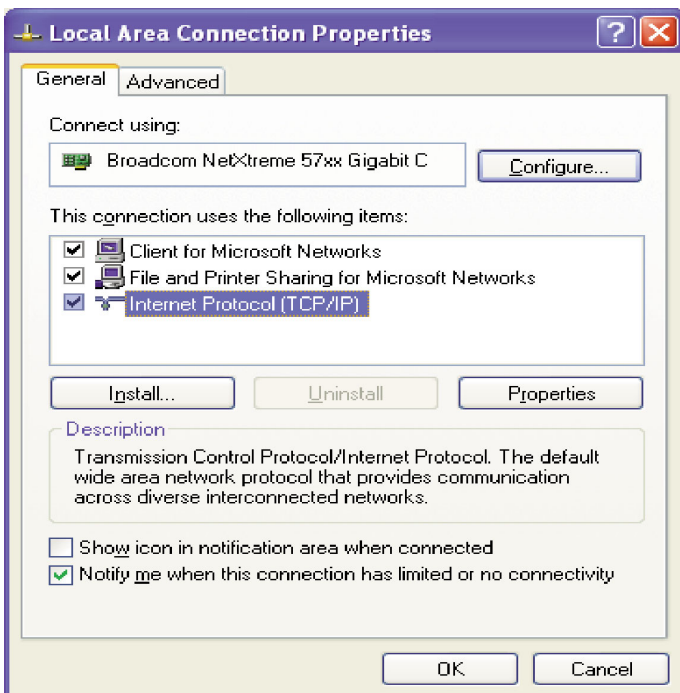

Broadcast Tools products, as any electronic device, can fail ...



For safety, **DO NOT** connect ...



Helpful tips area.

WEBSITE:

Visit our web site for product updates and additional information.

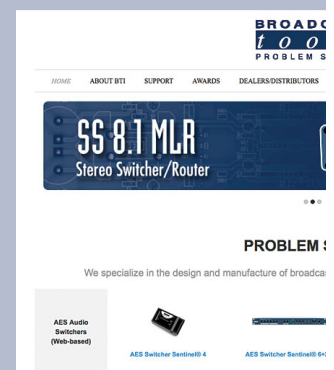

Step 4: On the Local Area Connection Properties page, double click on Internet Protocol (TCP/IP) to display properties.

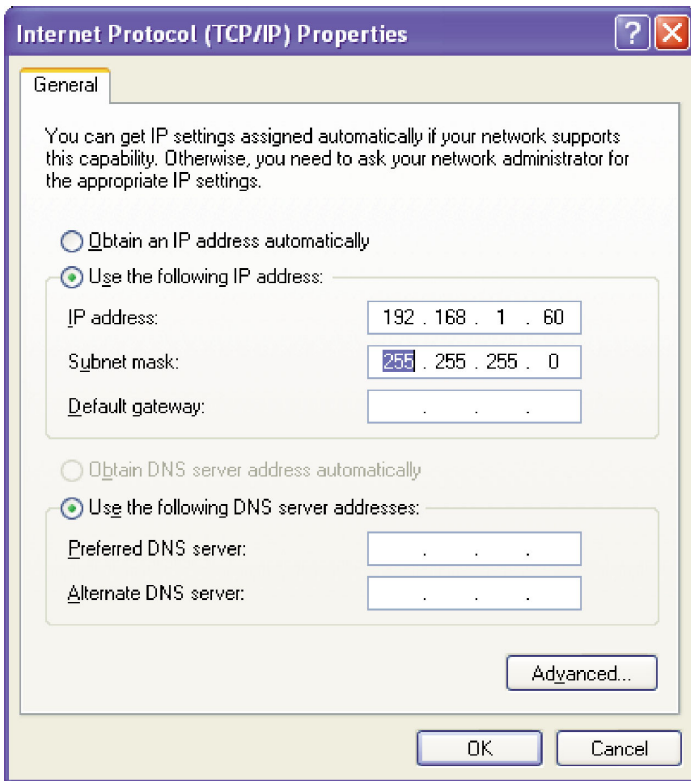

Step 5: Before making any changes to the network settings, write down the current settings (or screen capture the page and print) so that they can be restored once the unit is configured. Next, select the radio button labeled “Use the following IP address” and type in the IP address 192.168.1.60. Type in the subnet mask of 255.255.255.0. Leave the default gateway field blank. Click OK to apply the new settings.

WEBSITE:

Visit our web site for product updates and additional information.

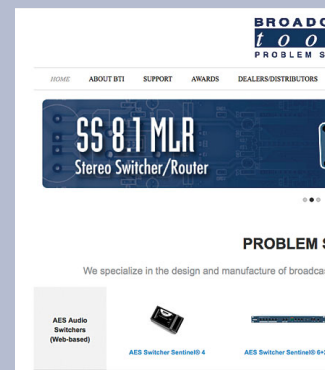

Ethernet (NETWORK) port LED indicator functions

| Link LED Left Side | |
|-----------------------|----------|
| Color | Meaning |
| Off | No Link |
| Amber | 10 Mbps |
| Green | 100 Mbps |

| Activity LED Right Side | |
|----------------------------|-------------|
| Color | Meaning |
| Off | No Activity |
| Amber | Half Duplex |
| Green | Full Duplex |

NOTE: We recommend the use of Firefox or Safari for Windows as your browser.

Opening the LOGIN Web Page

1. Connect the supplied GRAY colored XOVER cable between the PC's Ethernet port and the products "NET" network RJ45's jack.
2. Connect the supplied 9 Volt DC @ 660 milliamp power supply to the product's power jack labeled Power 9-12 VDC. Verify that the green PWR/Heartbeat LED is blinking and the left "LINK" LED above the "NET" Network RJ-45 is illuminated
3. Open the product's login page by typing the following URL into the browser: <http://192.168.1.55> The username and password is required to change any parameter and the fields are case sensitive.

Factory "login" defaults: username: admin (lower case)
password: 1234

NOTE: You may view the password by checking the "Show Password" box.

4. Press the "Submit" button to login in. Once you are logged in, follow this manual for setup and/or operational information.

WEBSITE:

Visit our web site for product updates and additional information.

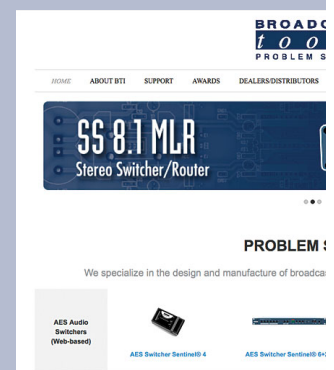

“Login” Web Page

The Login screen displays the Username and Password entry points.

BROADCAST tools **AUDIO Sentinel®** Login

Time/Date 11:12:06 9/2/2015
Site ID SITE_ID

Enter Login Information:

Username
Password show password

After you have successfully logged in, the Monitor/Control page will be displayed. Depending on your access level, you may or may not be able to control or modify the product’s configuration.

WEBSITE:

Visit our web site for product updates and additional information.

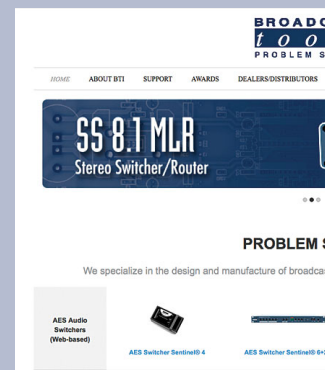

The Monitor/Control page allows the monitoring and or control of the Audio Sentinel. The following is an explanation of each item on this page:

User defined Site ID, Time and Date are always displayed.

Queued Logs: Displays the number of queued logs.

Input Labels: User defined in the Silence Sensor setup page

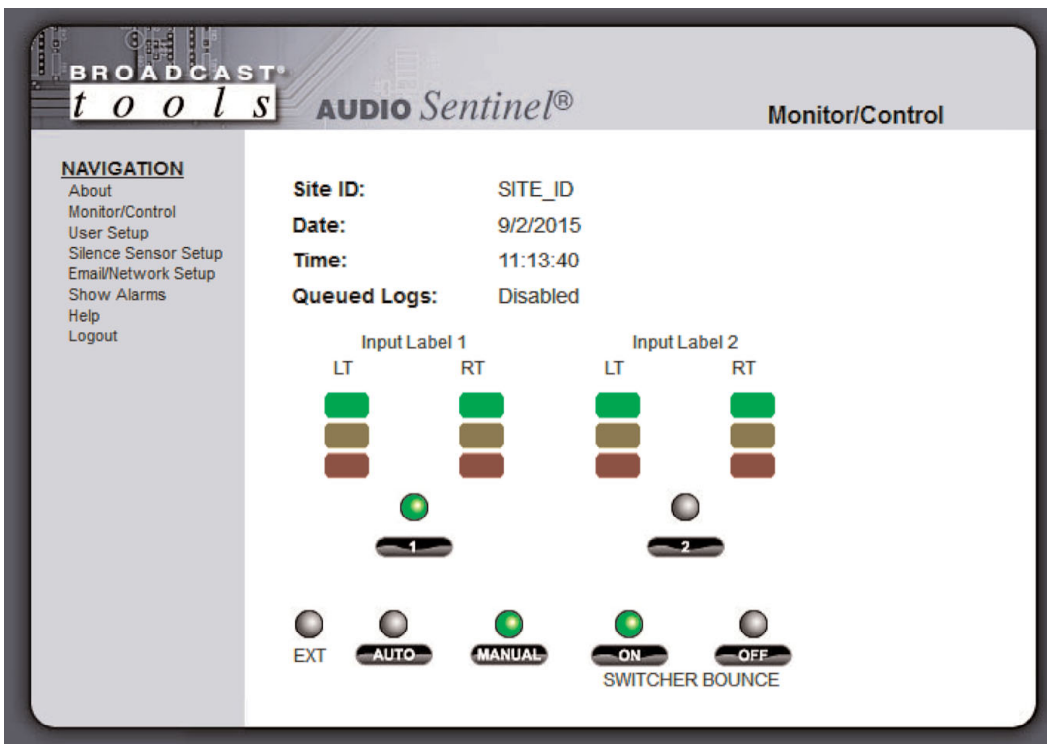

Left/Right Level Meters: Display the left and right input audio levels for inputs one and two. The green indicators are lit when audio is -19 db and above. The yellow and red indicators are lit when the input audio is either above (yellow) or below (red) the programmed trip levels.

WEBSITE:

Visit our web site for product updates and additional information.

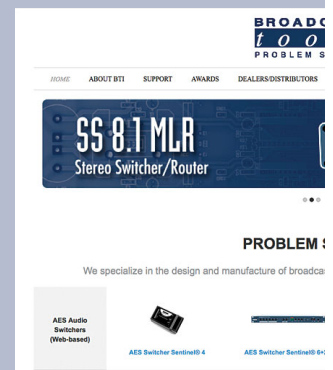

- Input Selection buttons:** If the unit is in manual mode, the user may switch between each input by placing the cursor under each input LED, then click. The desired input is selected as denoted by the LED being illuminated.
- EXT LED:** Illuminates when the “SELECT/EXT” input is active.
- AUTO:** When this mode is selected, any time input ONE fails, the unit will switch to input TWO. Manual and remote operation of the unit is disabled except for “SUSTAINED” operation. The LED is illuminated when selected.
- MANUAL:** Manual mode allows the user to select either input one or two as well as remote control operation. The manual LED is illuminated when selected.
NOTE: Email alerts are not generated by manual switching.
- SWITCHER BOUNCE:** Allows the switcher to automatically switch between inputs when in AUTO mode and valid audio and time delays have expired. .

WEBSITE:

Visit our web site for product updates and additional information.

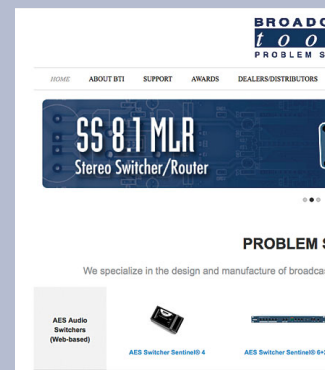

“User Setup” Web Page

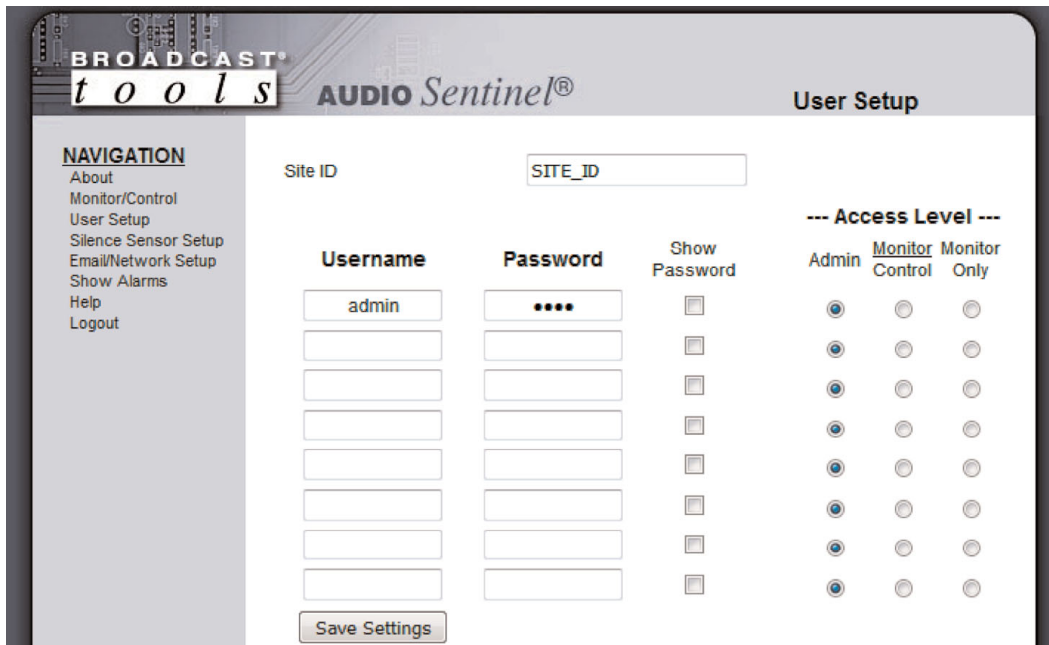

NOTE: You may view a password by checking the “Show Password” box.

Eight Usernames and Passwords may be configured for one of three access levels:

1. “Admin” allows complete configuration access and control.
2. “Monitor/Control” allows the following access:
About, Monitor/Control, Show log, Help, and Logout.
3. “Monitor Only” allows the following access:
About, Monitor only, Help, and Logout.

Only users with “admin” access can make changes to this page. The site ID is displayed and can be changed on the Email/Network Setup page.

NOTE: After any item has been changed, you **MUST** press the “Save Settings” button for your changes to be saved.

WEBSITE:

Visit our web site for product updates and additional information.

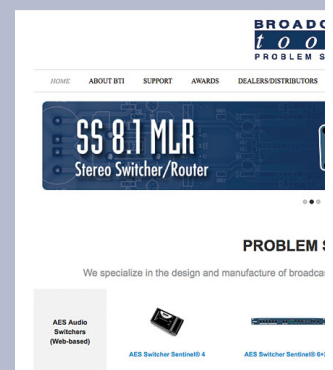

BROADCAST
tools

AUDIO Sentinel®

Silence Sensor Setup

NAVIGATION

- About
- Monitor/Control
- User Setup
- Silence Sensor Setup
- Email/Network Setup
- Show Alarms
- Help
- Logout

Input 1 Label

Input 1 Delay (Sec)

Input 1 Restore (Sec)

Input 1 Trip Level (dB)

Input 1 dual mono mode

Input 2 Label

Input 2 Delay (Sec)

Input 2 Restore (Sec)

Input 2 Trip Level (dB)

Input 2 dual mono mode

| Alarms | Email Addresses | | | | | | | |
|-------------------------------------|-------------------------------------|--------------------------|--------------------------|--------------------------|--------------------------|--------------------------|--------------------------|--------------------------|
| Input 1 Silent | 1 | 2 | 3 | 4 | 5 | 6 | 7 | 8 |
| <input checked="" type="checkbox"/> | <input checked="" type="checkbox"/> | <input type="checkbox"/> | <input type="checkbox"/> | <input type="checkbox"/> | <input type="checkbox"/> | <input type="checkbox"/> | <input type="checkbox"/> | <input type="checkbox"/> |
| Input 2 Silent | 1 | 2 | 3 | 4 | 5 | 6 | 7 | 8 |
| <input checked="" type="checkbox"/> | <input checked="" type="checkbox"/> | <input type="checkbox"/> | <input type="checkbox"/> | <input type="checkbox"/> | <input type="checkbox"/> | <input type="checkbox"/> | <input type="checkbox"/> | <input type="checkbox"/> |

Independent mode

Ext-Input Function Sustained
 Input Toggle

K3 Configuration

When Is Active delay sec. then engage for sec.

K4 Configuration

When Is Active delay sec. then engage for sec.

WEBSITE:

Visit our web site for product updates and additional information.

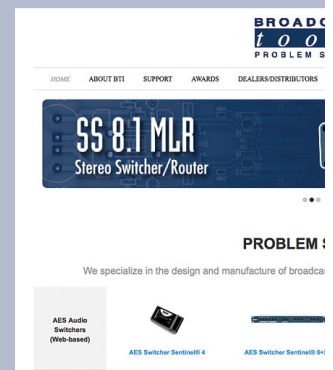

OPERATION

“Silence Sensor Setup” Web Page

NOTE: The delay and restore timing for both channels is 0 (OFF) to 65535 seconds (18 hours, 12 minutes and 15 seconds).

| | |
|-------------------------------|--|
| Input 1 Label: | Up to 18 characters may be entered to describe input 1. |
| Input 1 Delay (Sec): | This is the time from when the left, right or both inputs for input ONE fall below the trip level to when it switches to input TWO and an alarm is generated. |
| Input 1 Restore Delay (Sec): | This is the time required for valid stereo audio to return and remain present before the unit switches back to input ONE and clears the alarm. |
| Input 1 Trip Level (db): | The left, right or both input levels below which input audio is considered BAD. |
| Input 1 dual input mono mode: | When dual input mono mode is selected, both the left and right inputs must be below the trip level before the input is considered BAD and the audio is switched. |
| Input 1 Alarms: | When checked, the unit logs an alarm when the silence sensor enters or exits an alarm condition, up to eight email addresses may receive alarm emails. |
| Input 1 email addresses: | The boxes labeled 1-8 allow the user to assign up to eight different email addresses for alarm notification. |
| Input 2 Label: | Up to 18 characters may be entered to describe input 2. |
| Input 2 Delay (Sec): | This is the time from when the left, right or both inputs for input TWO fall below the trip level to when an alarm is generated. |
| Input 2 Restore Delay (Sec): | This is the time required for valid stereo audio to return and remain present before the unit clears the alarm. |
| Input 2 Trip Level (db): | The left, right or both input levels below which input audio is considered BAD. |
| Input 2 dual input mono mode: | When dual input mono mode is selected, both the left and right inputs must be below the trip level before the input is considered BAD and an alarm is generated. |

WEBSITE:

Visit our web site for product updates and additional information.

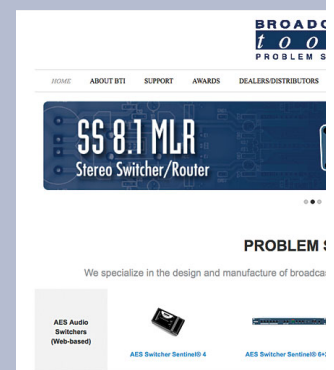

- Input 2 Alarms:** When checked, the unit logs an alarm when the silence sensor enters or exits an alarm condition, up to eight email addresses may receive alarm emails.
- Input 2 email addresses:** The boxes labeled 1-8 allow the user to assign up to eight different email addresses for alarm notification.
- Independent:** When this mode is selected, the unit acts as two Independent silence sensors. In this mode audio switching disabled.
- Ext-Input Function:** Selects how the “Select/EXT” input will function. Operation is described in the Manual Operation section of this manual.
- K3 and K4 logic operation:** Each relay may be programmed to operate when an input is silent, active (switched to) or inactive (not switched to). The logic for each relay is as follows:

When [input 1 or input 2] [Is Active, Inactive or Silent] delay [X] seconds then [Engage] for [X] seconds.

NOTE: Delay timing = 0 (OFF) to 65535 seconds (18 hours, 12 min and 15 sec’s).

NOTE: To enable relay latch/sustained type operation, the [Engaged] delay should be set to 0.

NOTE: Press the “Save Settings” button to save your changes.

WEBSITE:

Visit our web site for product updates and additional information.

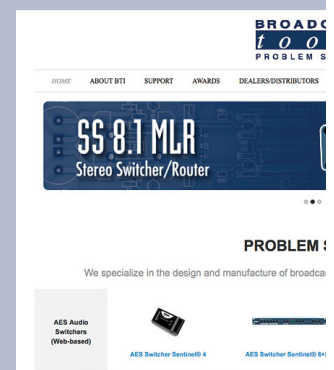

BROADCAST
t o o l s
AUDIO Sentinel®
Email / Network Setup

NAVIGATION

- About
- Monitor/Control
- User Setup
- Silence Sensor Setup
- Email/Network Setup
- Show Alarms
- Help
- Logout

Device Address

Device Netmask

Gateway Address

DNS Server Address

HTTP Port

SMTP Server Address

SMTP Port

SMTP Return Address

SMTP Host ID

SMTP Authentication

SMTP Username

SMTP Password show password

Logging Email Address

Logging Email Snapshot Interval (Hours)

Logging Email Update Interval (Hours)

Email Alarms Immediately
 Daily

Daily Alarm Email Time (Hour)

Recipient Addresses

1

2

3

4

5

6

7

8

SNMP Trap IP Address 1

2

SNMP Manager Trap Port

SNMP Read Community

SNMP Write Community

SNMP Enable Traps

NTP Server Address

NTP Port

NTP Update Interval (Minutes)

NTP Enabled

Site ID

Monitor Refresh Time Seconds

MTU Size

Time Zone Offset from UTC

Enable Event Logging Login
 Email
 Reboot
 Alarms Cleared

Save Settings
Reboot Device

Send Test E-mail
Reload Defaults

Clear Daily Logs
Send Daily Logs

WEBSITE:
Visit our web site for product updates and additional information.

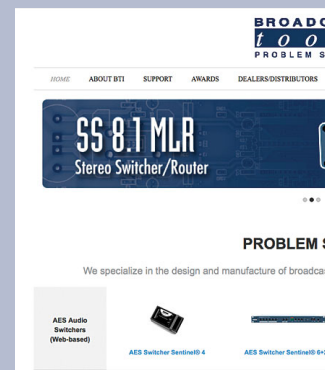

Web Setup and Operation

NOTE: Restoring Factory Default Settings

The Audio Sentinel® can be reset to default settings by depressing the recessed front panel “default” push button for five seconds while powering up the unit.

“Email/Network Setup” Web Page – Device Network Settings

Device Address: Enter a static IP address here. Default: 192.168.1.55

Device Netmask: Enter the Netmask here: Default: 255.255.255.0

Gateway Address: Enter the Gateway IP here: Default: 192.168.1.1

DNS Server IP Address: Enter your DNS address here. Default: 192.168.1.1

HTTP Port: Normally Port 80 Default: 80

“Email/Network Setup” Web Page – SMTP Settings

SMTP Server Address: The user can enter either an IP address in the xxx.xxx.xxx.xxx format or a URI in the form: smtp.comcast.net. In order to resolve the URI, a working DNS server must be present or its IP address entered into the system.

SMTP Port: Normally Port 25 or 587 Default: 25

SMTP Return Address: Enter your return email address here. If an email cannot be delivered, a message stating why will be sent to this address.

SMTP Host ID: Enter something here to identify the device.

SMTP Authentication: When checked, Base64 SMTP authentication used. SSL/TLS secure authentication required by Gmail is not supported.

SMTP Username: Enter SMTP server user name here.

SMTP Password: Enter SMTP server password here.

WEBSITE:

Visit our web site for product updates and additional information.

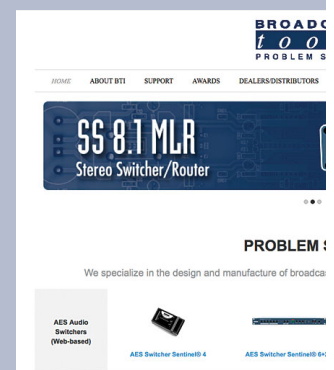

NOTE: The user must enter the following settings before an email can be successfully sent: SMTP Server Address, SMTP Port, SMTP Return Address, SMTP Host ID, SMTP username and SMTP password. Recipient addresses 1-8. The test email is sent to email recipient address 1.

The user should press the “Save Settings” button after entering the SMTP information before attempting an email test. If authentication fails, the email is not sent, please ensure that the username and password is correct.

“Email/Network Setup” Web Page – Email Logging Settings

Logging Email Address: IP address for the “Logging” email recipient (may be different from the 8 “Alarm” Recipient Addresses. Logging emails and Daily emails are sent to this address.

Logging Email Snapshot Interval: The period in hours that a snapshot is taken of the system. An email is not sent on this interval.

Logging Email Update Interval: The period in hours that the snapshots are emailed. This email may contain multiple snapshots if the Snapshot Interval is less than the Update Interval. Each snapshot will be identified by the date and time.

“Email/Network Setup” Web Page – Email Alarm Settings

Email Alarms: Choose Immediate and/or Daily. If Immediate is selected, then an email will be sent out as soon as an alarm is generated. If Daily is selected, then each alarm is queued and the number of queued alarms is displayed on the Monitor/Control page.

Daily Alarm Email Time: The time that queued alarms are sent. Queued alarms are sent to the Logging Email Address only.

“Alarm” Recipient Address: Email addresses for up to 8 addresses. These address correlate to the 8 email addresses selectable on each I/O Device.

“Email/Network Setup” Web Page – SNMP Manager Settings

SNMP Trap IP Address 1-2: SNMP traps can be sent to one or two IP addresses. Enter them here.

SNMP Manager Trap Port: This is the port number that SNMP trap messages will be sent. Default: 162

SNMP Read Community: This is the community name for Read-Only access. Default: public

WEBSITE:
Visit our web site for product updates and additional information.

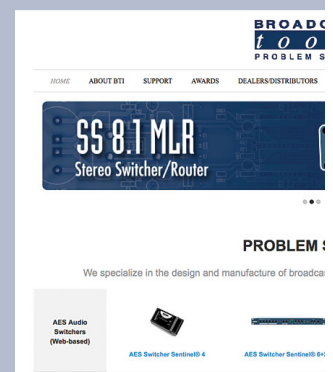

SNMP Write Community: This is the community name for Read-Write access.
Default: private

SNMP Enable Traps: When checked, trap messages will be sent when alarms are triggered. When unchecked, no trap messages will be sent.

NOTE: A cold-start trap will be sent when the unit boots up if the SNMP Enable Traps is checked, otherwise trap messages are sent when a device enters or exits an alarm condition, depending on whether or not alarms are enabled.

“Email/Network Setup” Web Page – NTP Time Sync Settings

NTP (Time) Server Address: Enter the NTP address here. Default: pool.ntp.org

NTP Port: Normally 123. Default: 123

NTP Update Interval (Min): Time between timing updates. Default: 30

NTP Enabled: Must be enabled for time sync. Default: Enabled

“Email/Network Setup” Web Page – Other Settings

Site ID: This is the Site Identifier that is displayed on the web page and included in emails.

Monitor Refresh Time (Sec): Interval at which the Monitor page refreshes. Shorter times may increase network traffic.

MTU Size: The Maximum Transmission Unit (MTU) is the largest physical packet size a network can transmit for TCP and UDP. Enter between 512 and 1400 bytes. The default is 1400 bytes.

Time Zone Offset from UTC: Sets the timezone using a UTC offset.
Default: -8

Enable Event Logging: Enabling these checkboxes will generate an alarm, but will not send an email. If the system is configured for Daily Alarm emails, then that Daily Alarm email will contain the Event Logging items as well.

Login: Whenever someone logs into the system, the username and date/time will be logged.

Email: Whenever an email is sent, the type of email and date/time will be logged.

WEBSITE:

Visit our web site for product updates and additional information.

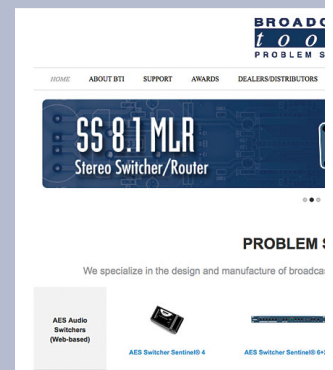

Reboot: Whenever the device boots, the date/time will be logged.

Alarms Cleared: Whenever the Daily Logs or Normal Alarms are cleared, the type of log cleared and date/time will be stored. When Daily Logs are sent, the Daily Logs are also cleared; this will cause an event log as well.

“Email/Network Setup” Web Page – Controls

Save Settings: After pressing the “Save Settings” button, the device will reboot (If you changed the IP address, you must navigate your web browser to the new IP address (if the HTTP port was changed from port 80, be sure to add the new port number after the IP: xxx.xxx.xxx.xxx:port #). If you didn’t change the IP address, then the web page will return to the login screen after the device reboots.

Reboot Device: When you press the “Reboot Device” button, the device restarts.

Send Test Email: Press this button to send a test email to recipient address #1. An alert box will pop-up indicating the status of the email and an error condition if the email was not sent correctly. If an email was not sent correctly, please review your SMTP settings and correct as necessary.

NOTE: After you are done making changes to the Email/Network Setup page, you **MUST** press the “Save Settings” button to save your changes.

Reload Defaults: When you press the “Reload Defaults” button, the device resets to default settings.

Clear Daily Logs: When you press the “Clear Daily Logs” button, the daily logs stored in memory will be cleared. Keep in mind that if the Alarms Cleared Event is enabled, this event will post after the logs are cleared.

Send Daily Logs: When you press the “Send Daily Logs” button, the system will send the daily logs email and then clear those logs as if the correct time has expired.

WEBSITE:

Visit our web site for product updates and additional information.

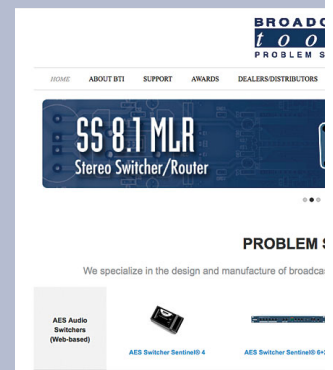

“Show Log” Web Page

BROADCAST tools AUDIO Sentinel® **Log**

NAVIGATION
 About
 Monitor/Control
 User Setup
 Silence Sensor Setup
 Email/Network Setup
 Show Alarms
 Help
 Logout

| Active Input | Input-1 Level | Input-2 Level | Auto/Manual | Switch Bounce | Date | Time |
|---------------|---------------|---------------|-------------|---------------|----------|----------|
| Input Label 2 | BAD | GOOD | AUTO | ON | 9/2/2015 | 11:29:32 |
| Input Label 1 | GOOD | GOOD | AUTO | ON | 9/2/2015 | 11:30:47 |

Last Updated 9/2/2015 11:30:48

Control
 Enable Sound
 Silence Alarms
 Clear Alarms

This page displays current alarms.

- Active Input: Displays which input was active.
- Input 1 Level: Displays if input ONE was GOOD or BAD.
- Input 2 Level: Displays if input TWO was GOOD or BAD.
- Auto/Manual: Displays which switching mode was selected.
- Switch Bounce: Displays if switch bounce mode was ON or OFF.
- Date: Displays the date the alarm was logged.
- Time: Displays the time the alarm was logged.

WEBSITE:

Visit our web site for product updates and additional information.

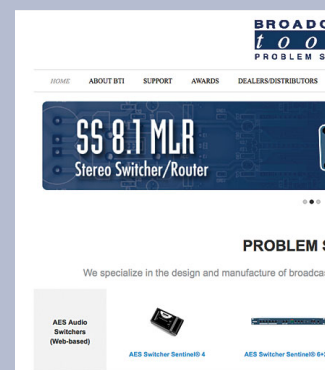

“About” Web Page

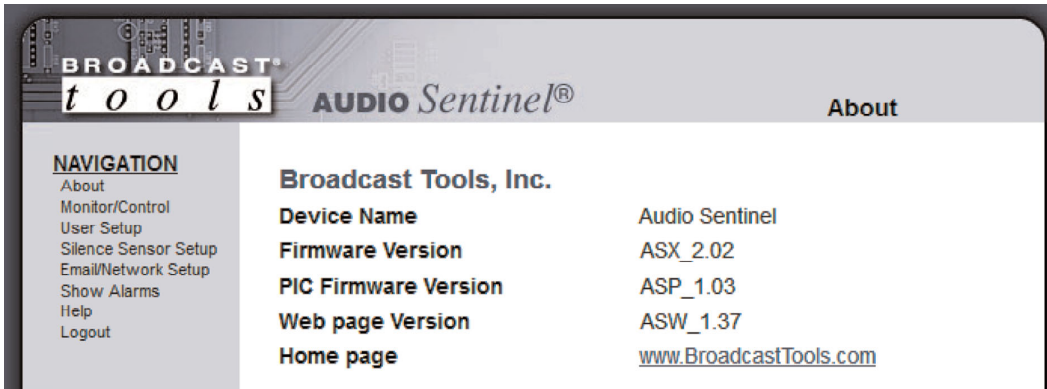

BROADCAST tools AUDIO Sentinel® About

NAVIGATION
About
Monitor/Control
User Setup
Silence Sensor Setup
Email/Network Setup
Show Alarms
Help
Logout

Broadcast Tools, Inc.

| | |
|-----------------------------|--|
| Device Name | Audio Sentinel |
| Firmware Version | ASX_2.02 |
| PIC Firmware Version | ASP_1.03 |
| Web page Version | ASW_1.37 |
| Home page | www.BroadcastTools.com |

The “About” web page displays the product name, firmware version numbers, and Broadcast Tools® web site link.

WEBSITE:

Visit our web site for product updates and additional information.

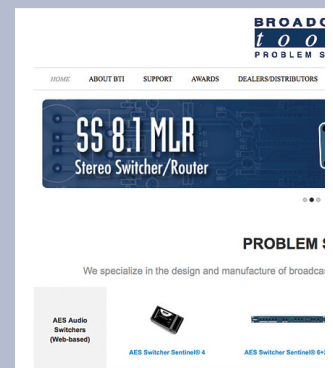

BROADCAST tools PROBLEMS

HOME ABOUT BTI SUPPORT AWARDS DEALERS/DISTRIBUTORS

SS 8.1 MLR
Stereo Switcher/Router

PROBLEM :
We specialize in the design and manufacture of broadcast

AES Audio Switchers (Web-based)
AES Switcher Sentinel® 4
AES Switcher Sentinel® 8x

Specifications

| | |
|--|---|
| Ethernet Interface: | RJ-45, 10base-T or 100base-TX, auto sensing with link & activity LED indicators - Full/half duplex. |
| Protocols: | TCP/IP, UDP/IP, ARP, ICMP, SNMP, TFTP, Telnet, DHCP, BOOTP, HTTP, and AutoIP. |
| Input Level: | -14 to +24 dBu, 22 K ohm, balanced. |
| Transparent (4PDT) Program switcher: | Any input level and impedance can be used. Inputs may be balanced or unbalanced. Output levels, impedance, distortion, noise and balancing will match that of the selected input. |
| Silence Sense (1 & 2) Level: | -24 to -35 dB below normal level, in 1dB steps. |
| Alarm Delay(1 & 2), Restore Delay(1 & 2) Time: | 0 (OFF) to 65535 seconds (18 hours, 12 minutes and 15 seconds). |
| Select/EXTERNAL Input: | Closure to ground. Pulled up to 5 VDC. (Sustained or momentary depending on mode). |
| Relays (K3, K4, K5): | SPDT (K5) and DPDT (K3, K4) dry contacts, 30 VDC @ 1 Amp maximum rating. |

CAUTION! For safety, never connect 120 Vac circuits to the above relays!

| | |
|------------------------|---|
| Connectors: | All I/O, removable euro-block screw terminals. Mating plugs supplied. |
| EMI / FCC Compliance: | See the Declaration of Conformity page. Operation is subject to the following two conditions: 1) This device may not cause harmful interference, and 2) this device must accept any interference received, including that which may cause undesired operation. |
| Required power supply: | 9 to 12 VDC @ 660 mA. CE certified universal switching 9 VDC adapter with domestic AC connector supplied. International connectors optional. |
| Size: | 5.66" x 7.00" x 1.58", aluminum extrusion chassis w/ 4 - 4-40 (or 6/32 screw threads) mounting holes. |
| Weight: | 2.0 lb. |
| Options: | * International AC Plug kit for wall power supply. * RA-1, 1-RU rack shelf. Accommodates 3 units. |

WEBSITE:

Visit our web site for product updates and additional information.

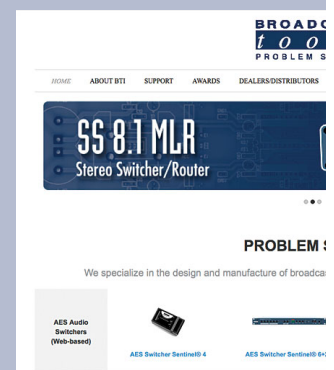

SPECIFICATIONS

LIMITED WARRANTY

The term “Buyer” as used in this document refers to and includes both (but only) (a) any person or entity who acquires such an item for the purpose of resale to others (i.e., a dealer or distributor of an item), and (b) the first person or entity who acquires such an item for such person’s or entity’s own use.

Broadcast Tools warrants to each Buyer of any item manufactured by Broadcast Tools that the item will be free from defects in materials and workmanship at the time it is shipped by Broadcast Tools if the item is properly installed, used and maintained.

EXCLUSIVE REMEDIES

If Broadcast Tools is notified, in writing, of a failure of any item manufactured by Broadcast Tools to conform to the foregoing Limited Warranty within one (1) year following the date of the Buyer’s acquisition of the item, and if the item is returned to Broadcast Tools in accordance with Broadcast Tools’ instructions for confirmation by inspection of the defect (which at Broadcast Tools’ election may include, without limitation, a requirement that the Buyer first obtain a Return Authorization number from Broadcast Tools, that the Buyer furnish proof of purchase in the form of an invoice and/or receipt, and that the Buyer prepay all freight charges associated with any return of the item to Broadcast Tools using such freight service as Broadcast Tools reasonably may specify), Broadcast Tools will repair or replace the defective item, or will refund the purchase price paid by the Buyer for the item. Broadcast Tools shall have the exclusive right to choose between these alternative remedies.

NO OTHER WARRANTIES OR REMEDIES

TO THE MAXIMUM EXTENT PERMITTED BY APPLICABLE LAW, BROADCAST TOOLS AND ITS SUPPLIERS DISCLAIM ALL OTHER WARRANTIES, EITHER EXPRESS OR IMPLIED, INCLUDING BUT NOT LIMITED TO IMPLIED WARRANTIES OF MERCHANTABILITY OR FITNESS FOR A PARTICULAR PURPOSE; AND THE FOREGOING ALTERNATIVE REMEDIES SHALL BE EXCLUSIVE OF ALL OTHER REMEDIES. THIS LIMITED WARRANTY GIVES YOU SPECIFIC LEGAL RIGHTS. YOU MAY HAVE OTHER RIGHTS, WHICH VARY FROM STATE/JURISDICTION TO STATE/JURISDICTION.

NO LIABILITY FOR CONSEQUENTIAL DAMAGES

TO THE MAXIMUM EXTENT PERMITTED BY APPLICABLE LAW, NEITHER BROADCAST TOOLS NOR ANY OF ITS SUPPLIERS SHALL HAVE ANY LIABILITY FOR ANY SPECIAL, INCIDENTAL, INDIRECT, CONSEQUENTIAL OR PUNITIVE DAMAGES WHATSOEVER (INCLUDING, WITHOUT LIMITATION, ANY DAMAGES FOR LOST PROFITS, BUSINESS INTERRUPTION, LOSS OF DATA OR INFORMATION, COST OF CAPITAL, CLAIMS OF CUSTOMERS, OR ANY OTHER PECUNIARY LOSS) ARISING OUT OF THE USE OF OR THE INABILITY TO USE ANY ITEM SUPPLIED BY BROADCAST TOOLS, EVEN IF BROADCAST TOOLS HAS BEEN ADVISED OF THE POSSIBILITY OF SUCH DAMAGES HAVE ANY LIABILITY FOR ANY SPECIAL, INCIDENTAL, CONSEQUENTIAL, EXEMPLARY OR PUNITIVE DAMAGES. THIS LIMITATION OF LIABILITY APPLIES WHETHER A CLAIM IS ONE ALLEGING BREACH OF A CONTRACT OR WARRANTY, NEGLIGENCE OR OTHER TORT, FOR THE VIOLATION OF ANY STATUTORY DUTY, THE FAILURE OF ANY LIMITED OR EXCLUSIVE REMEDY TO ACHIEVE ITS ESSENTIAL PURPOSE, OR ANY OTHER CLAIM OF ANY NATURE. BECAUSE SOME STATES AND JURISDICTIONS DO NOT ALLOW THE EXCLUSION OR LIMITATION OF LIABILITY FOR INCIDENTAL OR CONSEQUENTIAL DAMAGES, THIS LIMITATION MAY NOT APPLY TO YOU.

Broadcast Tools, Inc.

131 State Street
Sedro-Woolley, WA 98284 • USA

360.854.9559 **voice** • 866.783.1742 **fax**
support@broadcasttools.com **e-mail**
www.broadcasttools.com **website**

Declaration of Conformity

The XPORT Device contained in the Audio Sentinel® conforms to the following standards: (according to ISO/IEC Guide 22 and EN 45014)

Manufacturer's Name & Address:

Audio Sentinel®: Broadcast Tools®, Inc.
131 State Street, Sedro Woolley, WA 98284-1503 USA

XPort: Lantronix 15353 Barranca Parkway, Irvine, CA 92618 USA

Declares that the following product:

Product Name Model: XPORT™ Device Server

Conforms to the following standards or other normative documents:

Electromagnetic Emissions:

EN55022: 1998 (IEC/CSP1R22: 1993) Radiated RF emissions, 30MHz-1000MHz
Conducted RF Emissions – Telecom Lines – 150KHz – 30MHz
FCC Part 15, Subpart B, Class B
IEC 1000-3-2/A14: 2000
IEC 1000-3-3: 1994

Electromagnetic Immunity:

EN55024: 1998 Information Technology Equipment-Immunity Characteristics
Direct ESD, Contact Discharge
Indirect ESD
Radiated RF Electromagnetic Field Test
Electrical Fast Transient/Burst Immunity
RF Common Mode Conducted Susceptibility
Power Frequency Magnetic Field Test

Manufacturer's Contact:

Audio Sentinel® Broadcast Tools®, Inc.
131 State Street
Sedro Woolley, WA 98284-1503 USA
Tel: 360 . 854 . 9559 Fax: 866 . 783 . 1742

XPORT™

Lantronix:

Director of Quality Assurance
15353 Barranca Parkway, Irvine, CA 92618 USA
Tel: 949 . 453 . 3990 Fax: 949 . 453 . 3995

WEBSITE:

Visit our web site for product updates and additional information.

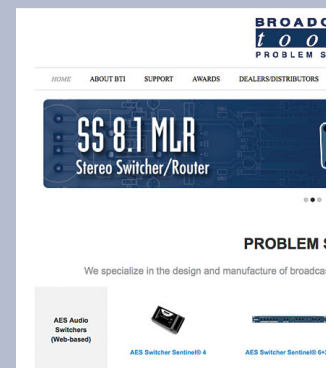

DECLARATION

Functional Diagram

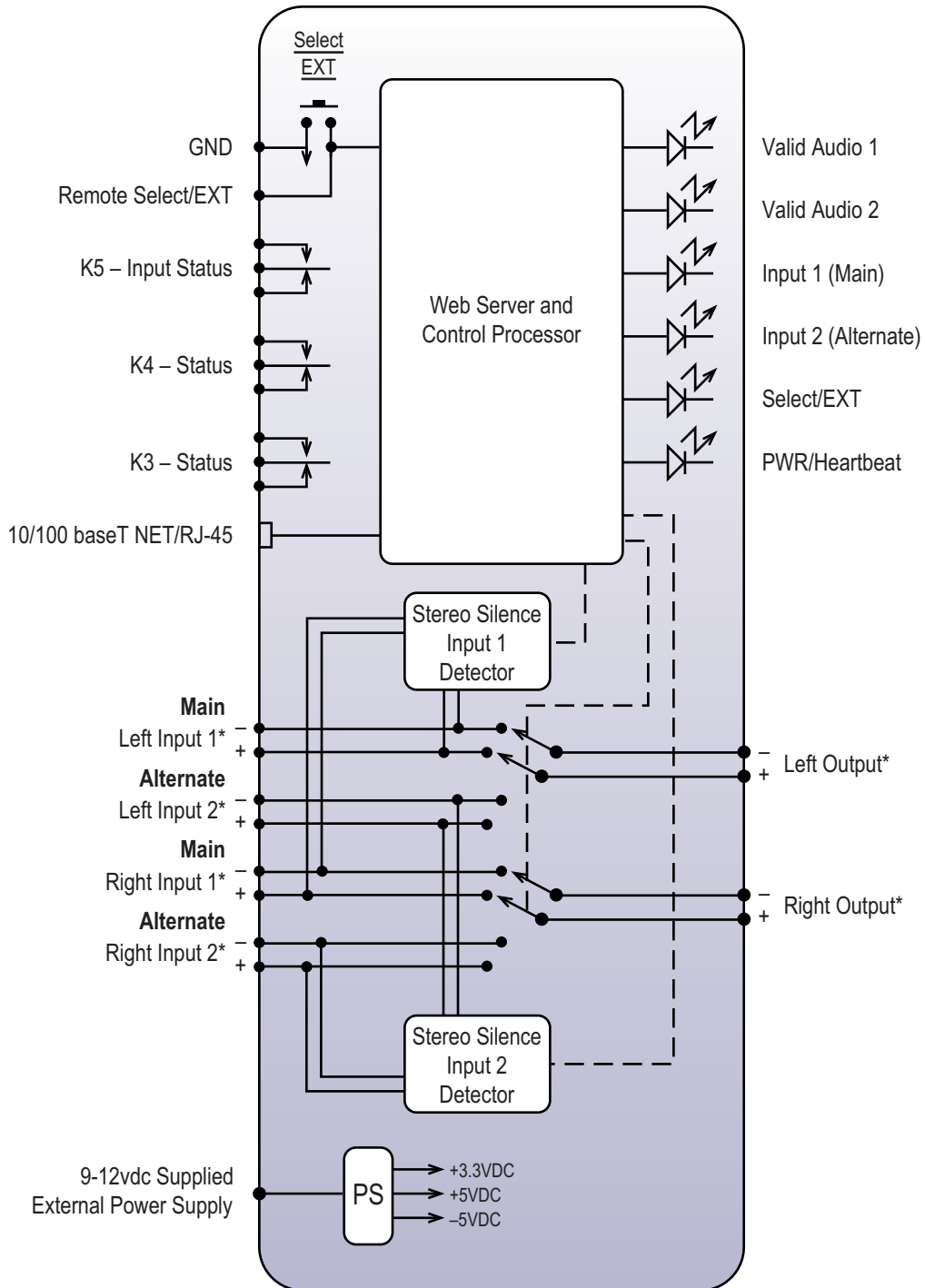

* Removable Screw Terminals

Audio Sentinel® + Web

Component Layout

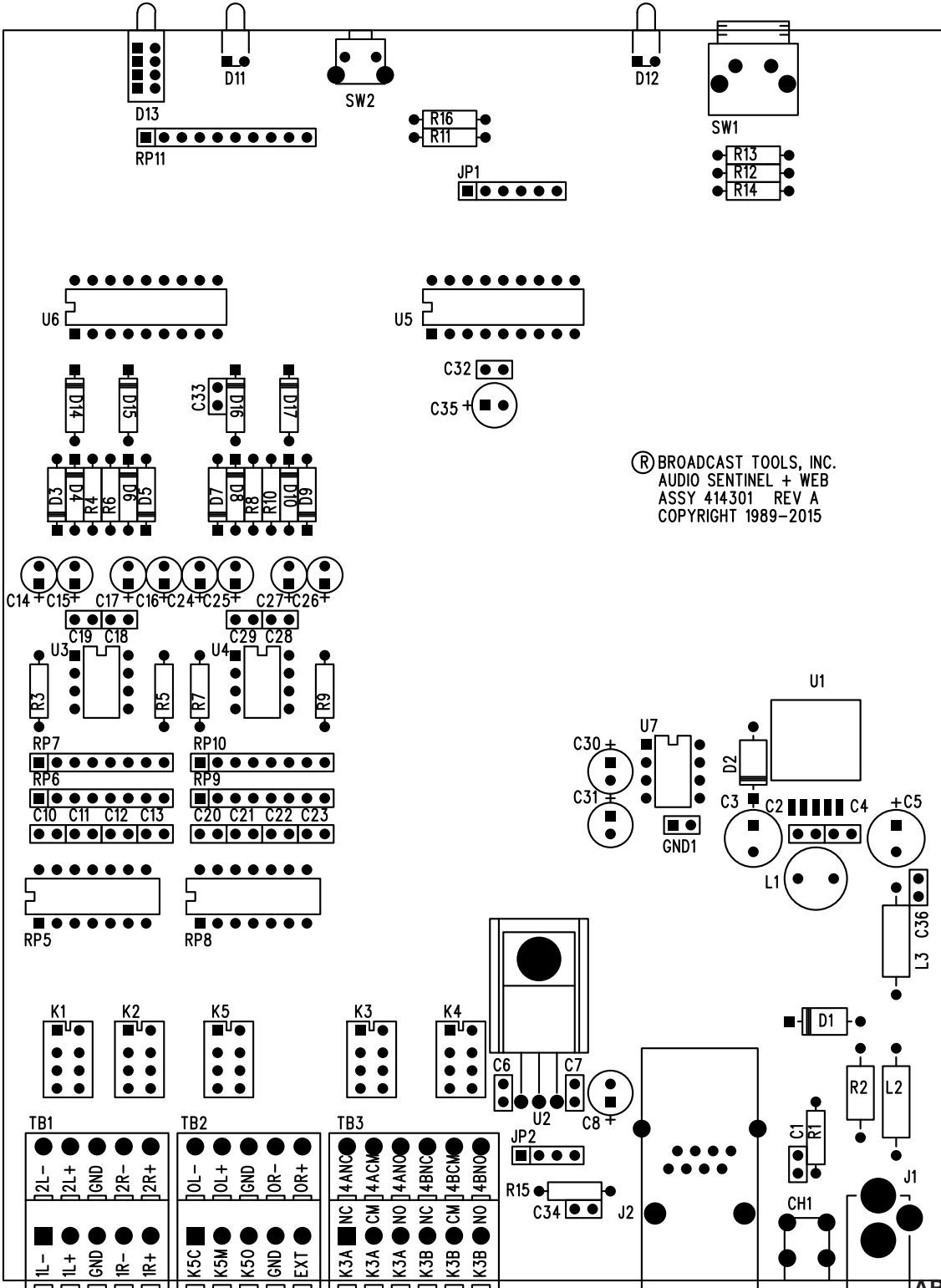

APPENDIX

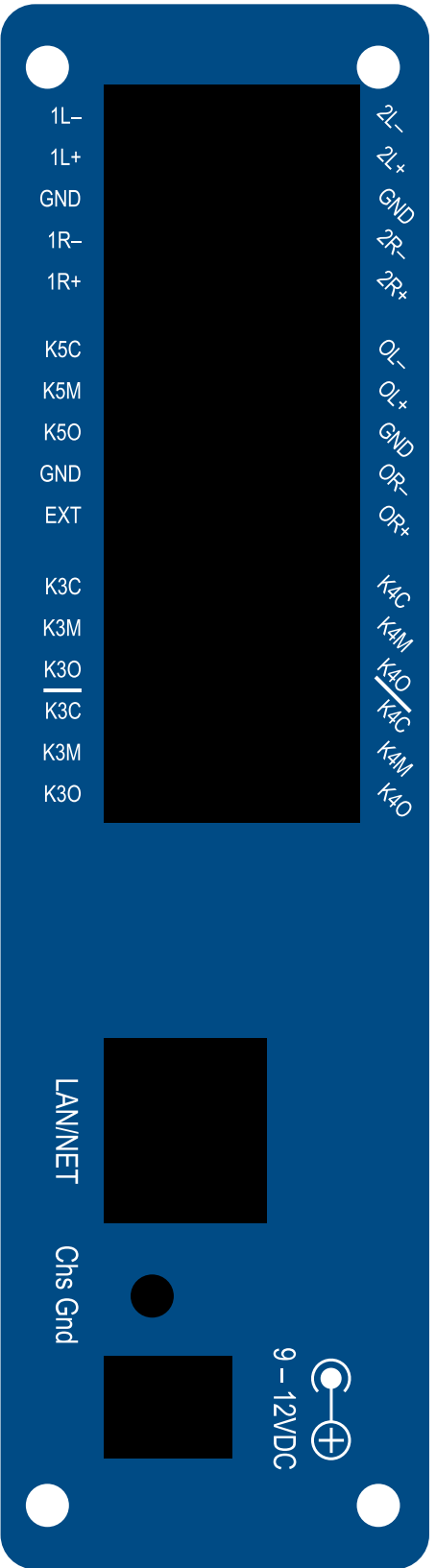

FRACTIONAL SCHEMATIC

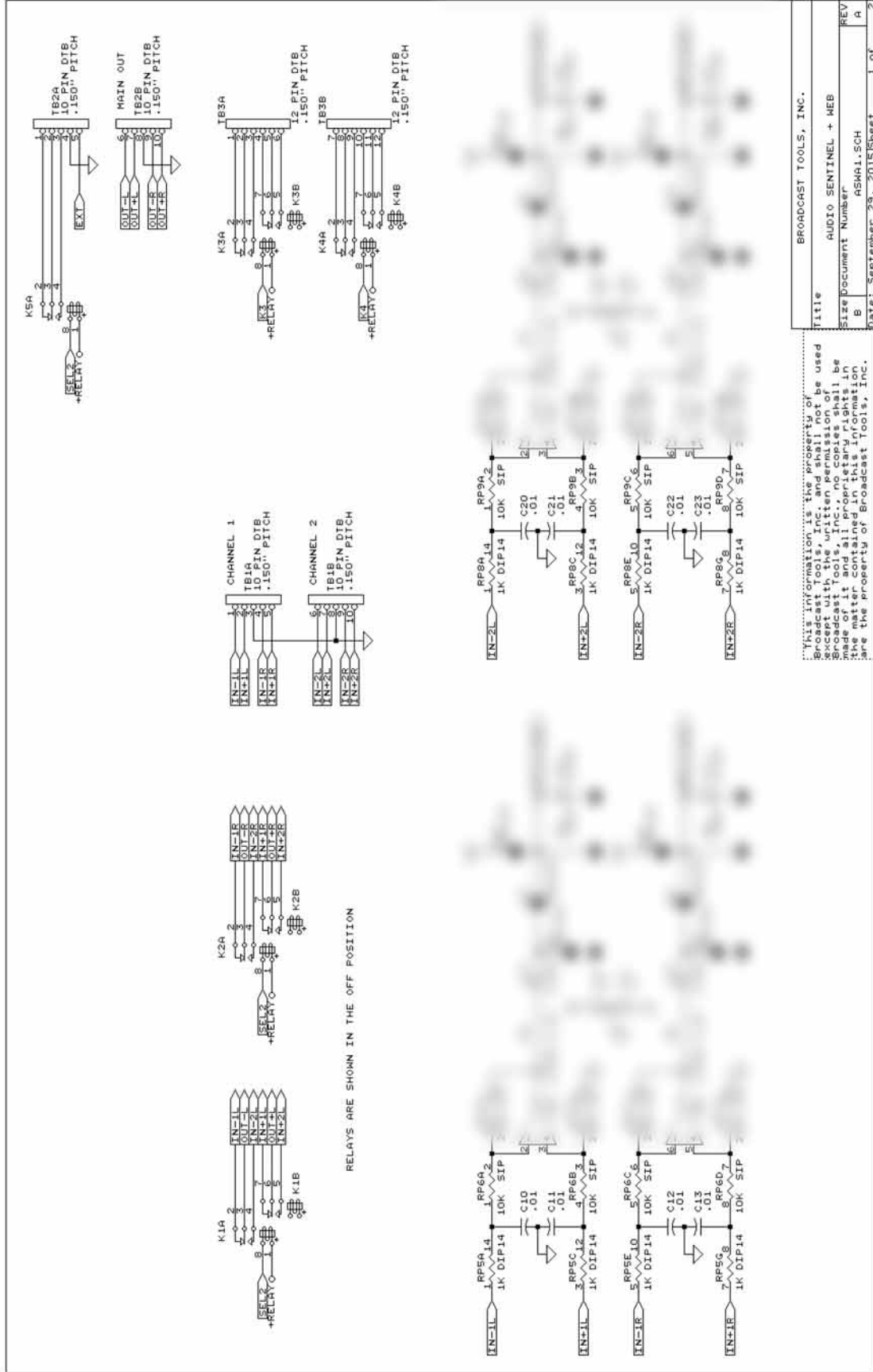

| | |
|-----------------------|----------------------|
| BROADCAST TOOLS, INC. | |
| Title | AUDIO SENTINEL + WEB |
| Size | Document Number |
| B | ASMA1.SCH |
| REV | A |
| Date: | September 29, 2015 |
| Sheet | 1 of 2 |

This information is the property of Broadcast Tools, Inc. and is to be used only for the specific project identified herein. Any other use, reproduction, or distribution without the written permission of Broadcast Tools, Inc., is prohibited. No copies shall be made of this document or the information contained herein without the written permission of Broadcast Tools, Inc.

FRACTIONAL SCHEMATIC

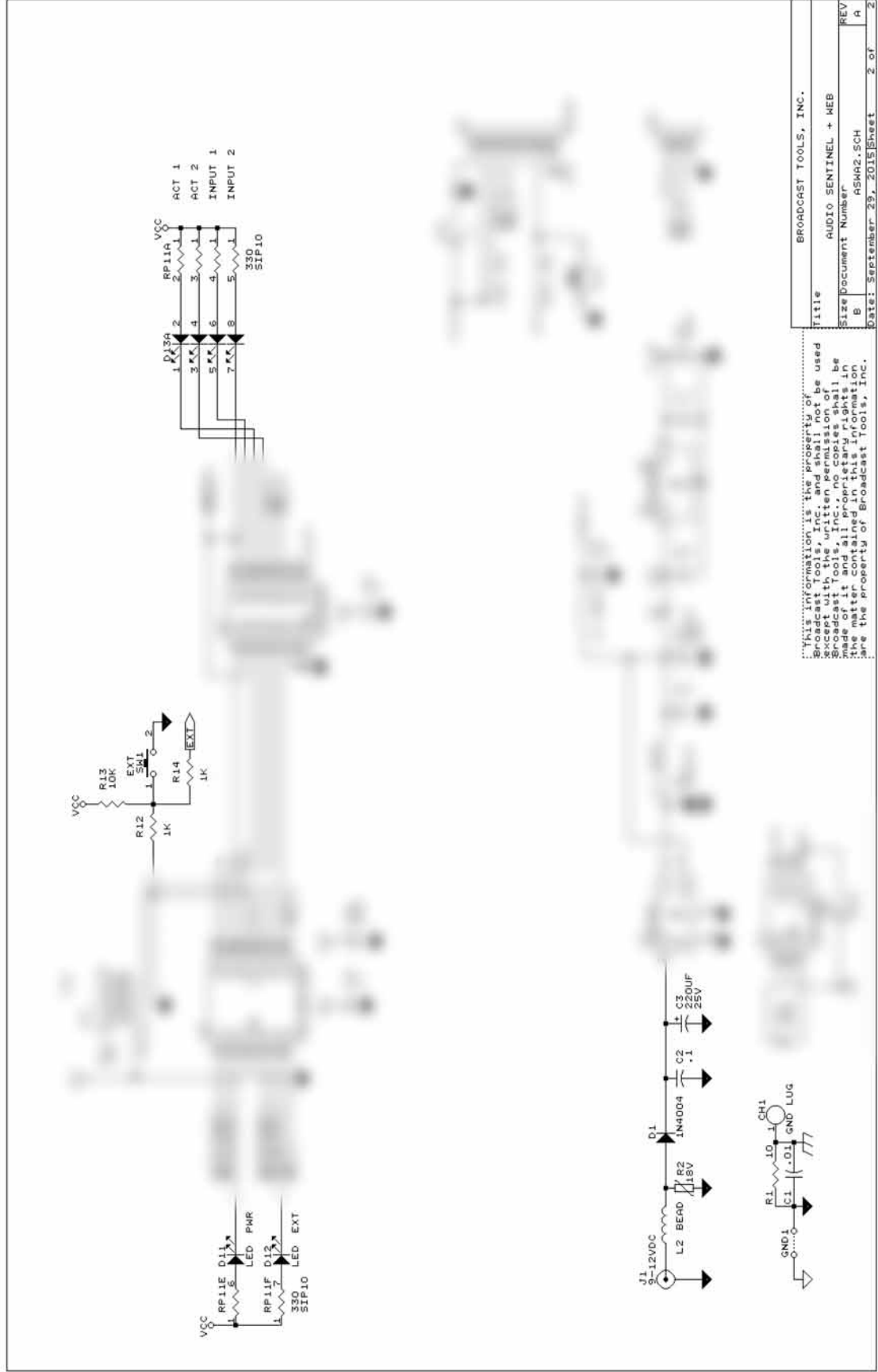

.....This information is the property of Broadcast Tools, Inc. and shall not be used except with the written permission of Broadcast Tools, Inc., no copies shall be made of it and all proprietary rights in it are reserved. All other components are the property of Broadcast Tools, Inc.

| | |
|-----------------|-----------------------|
| Title | BROADCAST TOOLS, INC. |
| Size | AUDIO SENTINEL + WEB |
| Document Number | ASMA2.SCH |
| REV | A |
| Date | September 29, 2015 |
| Sheet | 2 of 2 |

APPENDIX