

Oxygen3





Broadcast Mixing Console

HIGHLIGHTS

- Very competitive price
- Wide range of functions in small dimensions
- 2 built-in telephone hybrids
- 9 stereo inputs + 3 micro inputs
- Very easy to operate

 **OXYGEN 3** is a compact audio console for "on-air" and production in the broadcast radio field. It is very simple to use and provides maximum operating flexibility.

 The **OXYGEN 3** console is a complete and self-contained piece of hardware, requiring no additional equipment to operate. All relevant functions are built-in, such as 2 telephone hybrids with meeting capabilities, On Air lamp control, Monitor loudspeaker cut-off and Talk-Over facility. The console features 3 micro inputs and 9 stereo inputs (1 of which configured by default for Phono sources).

 **OXYGEN 3** console is available in two versions: with or without EQ controls on Input channels (respectively called **OXYGEN 3** and **OXYGEN 3 ST**). Each console has always two balanced outputs plus a number of unbalanced outputs provided on Pin RCA connectors.

PUNTI DI FORZA

- Prezzo estremamente competitivo
- Grandi funzionalità in piccole dimensioni
- 2 ibridi telefonici incorporati
- 9 ingressi stereo + 3 ingressi micro
- Grande semplicità operativa

 **OXYGEN 3** è una compatta console audio per applicazioni "on air" e di produzione radiofonica. La facilità d'uso e la versatilità ne costituiscono i principali punti di forza.

 **OXYGEN 3** è una console totalmente autocontenuta: non richiede cioè apparati o accessori addizionali per funzionare. Tutte le funzioni più importanti sono incorporate, come 2 ibridi telefonici con funzionalità di meeting, il controllo della lampada di "On-Air", il muting degli speaker Monitor e un circuito di Talk-Over. Tre sono gli ingressi microfonici e ben nove quelli stereo (uno dei quali configurato, di serie, per segnali Phono).

 **OXYGEN 3** è disponibile in due versioni: con o senza controllo di toni sui canali di ingresso (rispettivamente denominate **OXYGEN 3** e **OXYGEN 3 ST**). Ciascuna console è dotata di due uscite bilanciate e di varie uscite sbilanciate su connettore PinRca.

Furthermore, while the **OXYGEN 3** features unbalanced LINE inputs (PinRca connectors), the **OXYGEN 3 ST** features electronically balanced LINE inputs on Jack 1/4" female connectors.

The frame is inox steel & aluminium made, with wood finishing touch available as an option. Electronic components have been selected from the best on the market. In particular, the parts mostly subject to tear and wear (such as switchers, faders and potentiometers) are by Alps.

Two large LED meters with peak memory allow a constant and fine control of Master and Monitor signals. The external switching power supply, operating between 90 and 260 Vac, assures maximum reliability and a world-wide use.

Inoltre, mentre **OXYGEN 3** è dotato di ingressi di linea sbilanciati (connettori PinRca), la versione **OXYGEN 3 ST** dispone di ingressi di linea elettronicamente bilanciati su connettore Jack 1/4".

La meccanica della console è interamente realizzata in acciaio inox e alluminio. Su opzione, sono disponibili anche eleganti finiture in legno. La componentistica elettronica è selezionata tra la migliore disponibile sul mercato. In particolare, le parti soggette a usura (come slider, potenziometri e commutatori) sono di marca Alps.

Due grandi LED meter stereo, dotati di memoria di picco, permettono una costante e precisa monitoraggio dei segnali Master e Monitor. L'alimentatore switching esterno, operante con tensione di alimentazione compresa da 90 a 260 Vac, garantisce la massima affidabilità e la possibilità di collegamento diretto a tutte le reti elettriche del mondo.

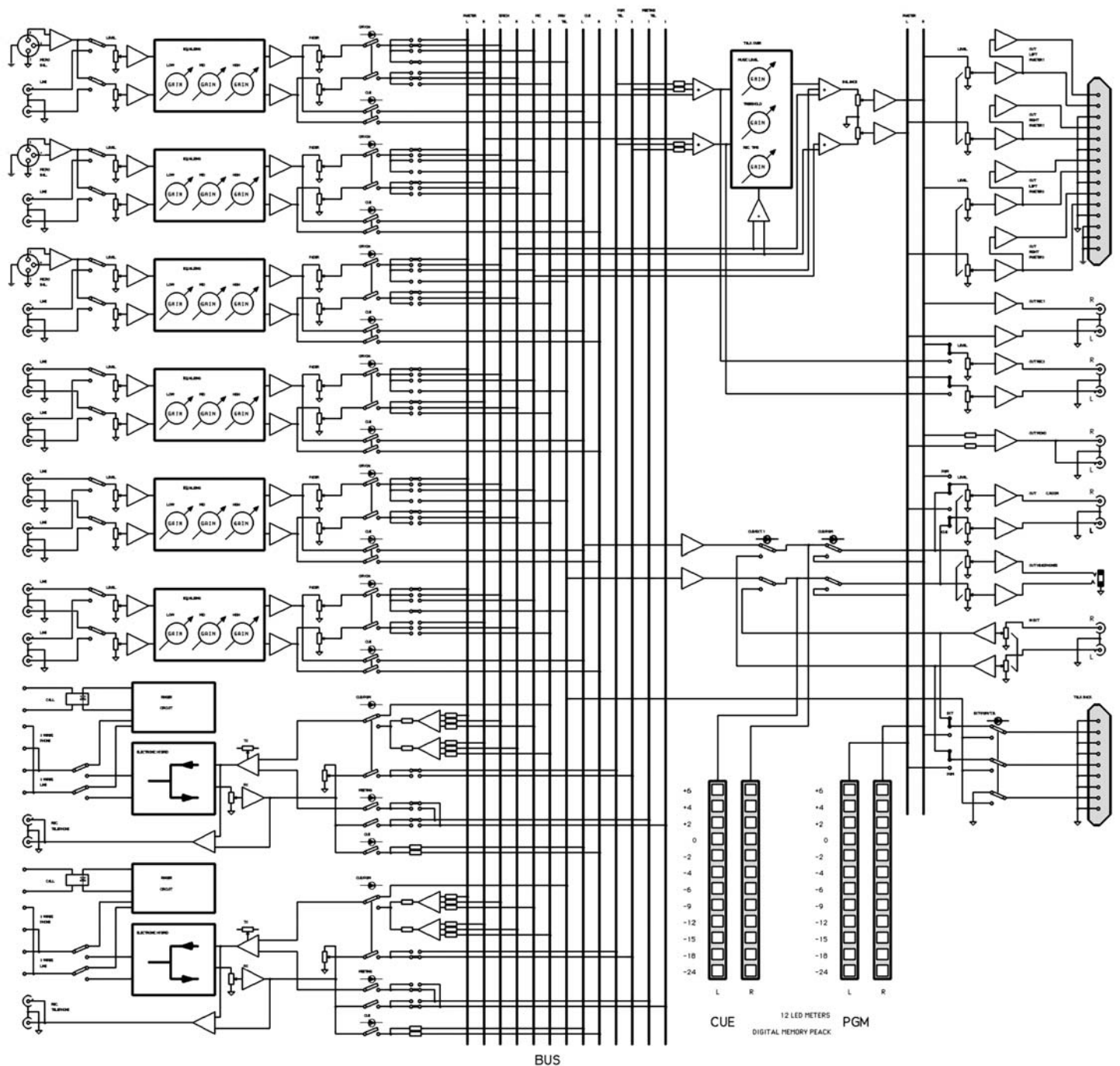

OXYGEN 3

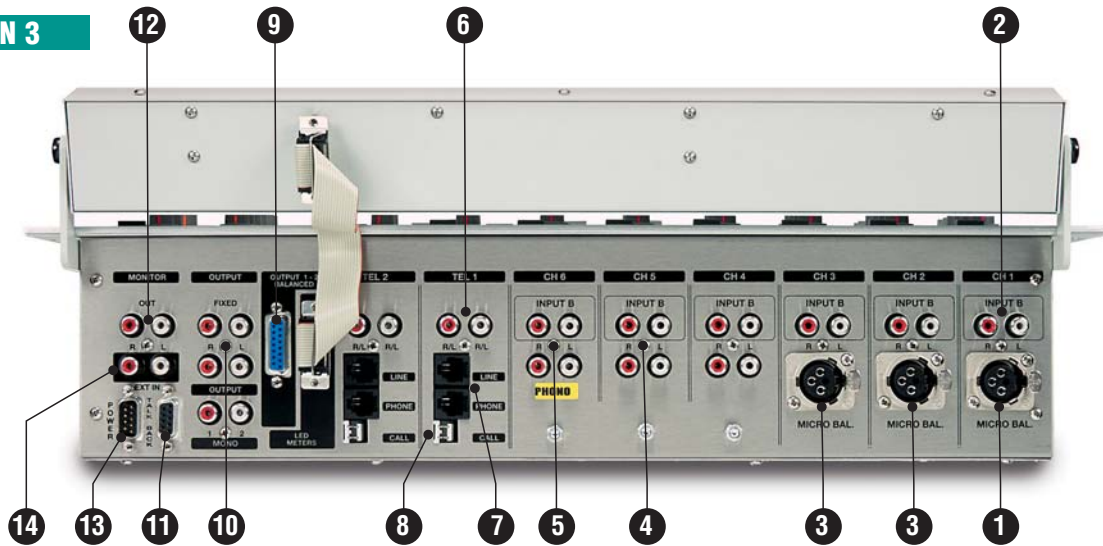

- 1 Balanced MICRO input. The Channel 1 may be regarded as a 'priority' channel: the Post-EQ (and pre-fader) Micro signal is always internally routed to the TalkBack circuitry and to the Telephone channels for 'private' (off-air) communications with the callers. The Post Fader, Master bus output is also routed to the TalkOver section for automatic voice/music mix. The slider opening is also associated with the Monitor output cut-off and with an insulated contact closing for On Air lamp control.
- 2 Unbalanced Stereo input for Line sources. Each channel has always two selectable inputs.
- 3 Balanced MICRO input. On request, Channel 2 and 3 can be fitted with facilities for Monitor output cut-off and On Air lamp control associated with the slider opening.
- 4 Both the stereo Inputs of Oxygen 3's Channels 4 and 5 are set by default for line level. On request, Input A on Channel 5 can be set as Phono input at the factory (ref to Phono2 option).
- 5 Channel 6 features a Stereo line input and a Phono input
- 6 Each telephone hybrid features double mono outputs for calls recording
- 7 Sockets for telephone line and external telephone set connection.
- 8 External call signalling. A photocoupler closes when the phone is ringing
- 9 Balanced Master output section, featuring two stereo outputs with level and balance controls. XLR external adapter available on request (ref. to ADPT option).
- 10 Unbalanced Master output section, featuring one unbalanced, level-controlled Stereo output (Out 3), one unbalanced, fixed level Stereo output and two Mono outputs.
- 11 Unbalanced TALKBACK / Master output (switched) The slider opening on Micro/Line channel 1 is also associated to a photocoupler closing for On Air Lamp control (such as MR. LIGHT by Axel Technology). On request, this facility may be extended to Micro/Line channels 2 and 3, too (ref. to CUT option)
- 12 Stereo line-level output, provided for connection to a power amplifier associated with loudspeakers. It allows monitoring of PFL and MASTER buses and EXTERNAL source. When microphone 1 is live to air, this output will be muted so that there is no acoustic feedback. On request, this facility may be extended to Micro/Line channels 2 and 3, too (ref. to CUT option)
- 13 Connection to the external AC adapter (provided)
- 14 Unbalanced stereo Input. It is intended to be connected to any external audio source (such as microwave, FM or satellite receivers) to be monitored.
- 15 Oxygen 3 ST console features balanced stereo inputs on Jack connector. Each channel has always two selectable inputs
- 16 Input B on Channel 6 is factory preset for Phono sources. Anyway, Input B configuration on Channels 4, 5 and 6 may be altered via internal jumpers at any time between Phono or Line settings.

OXYGEN 3 ST

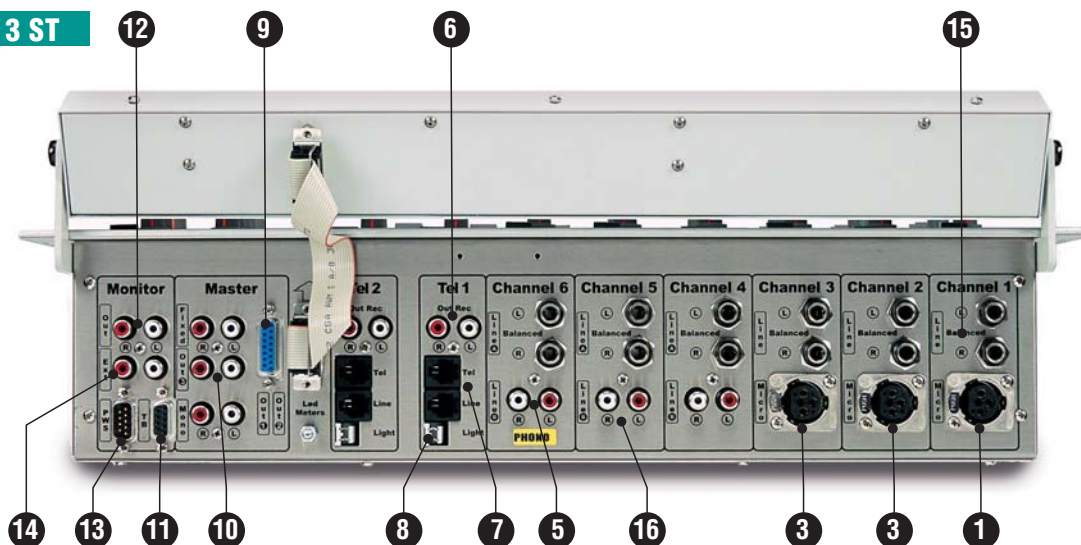

OPTIONS

| | | |
|---|---------------|--|
| Adapter Sub D / 4 XLR for balanced outputs | ADPT | Adattatore Sub D / 4 XLR per uscite bilanciate |
| Set 8 sliders Alps series K for all input channels | KSL | Kit 8 Slider stereo Alps serie K per i moduli di ingresso |
| Slider with switch for monitor loudspeaker cut off for additional Micro channel | CUT | Slider con funzione esclusione casse / accensione lampada On Air per canale Micro aggiuntivo |
| Wood frame finishing | WOOD | Rifinitura in legno del frame |
| Additional Phono Input (on Channel 5) for Oxygen 3 | PHONO2 | Ingresso Phono aggiuntivo (sul 5° canale) per Oxygen 3 |

TECHNICAL SPECIFICATIONS

OXYGEN 3

| | | | | | |
|---|----------------------------------|-------------------------------------|--|--------|---------------------|
| LINE-LINE & LINE PHONO STEREO MODULE | INPUT A | Stereo | | PinRCA | |
| | INPUT A levels | 0 dBm (LINE – Channels 4 - 5) Unbal | | | +/- 12 dB gain ctrl |
| | | Phono (RIAA – Channel 6) Unbal | | | +/- 12 dB gain ctrl |
| | INPUT B | Stereo | | PinRCA | |
| | INPUT B nominal level | 0 dBm (LINE) | | | +/- 12 dB gain ctrl |
| | INPUT A & B impedance | 10 kΩ | | | |

| | | | | | |
|-----------------------------|--------------------------|----------------------------|-------|--------|---------------------|
| MONO / STEREO MODULE | INPUT A | Mono - 70 dB (MICRO level) | Bal. | XLR | +/- 12 dB gain ctrl |
| | INPUT A impedance | > 1,5 kΩ | | | |
| | INPUT B | Stereo 0 dBm (LINE) | Unbal | PinRCA | +/- 12 dB gain ctrl |
| | INPUT B impedance | 10 kΩ | | | |

OXYGEN 3 ST

| | | | | | |
|---|----------------------------------|-------------------------------------|-----|-----------|---------------------|
| LINE-LINE & LINE PHONO STEREO MODULE | INPUT A | Stereo | Bal | Jack 1/4" | |
| | INPUT A nominal level | 0 dBm (LINE) | | | +/- 12 dB gain ctrl |
| | INPUT B | Stereo | | PinRCA | |
| | INPUT B levels | 0 dBm (LINE – Channels 4 - 5) Unbal | | | +/- 12 dB gain ctrl |
| | | Phono (RIAA – Channel 6) Unbal | | | +/- 12 dB gain ctrl |
| | INPUT A & B impedance | 10 kΩ | | | |

| | | | | | |
|-----------------------------|--------------------------|----------------------------|------|-----------|---------------------|
| MONO / STEREO MODULE | INPUT A | Stereo 0 dBm (LINE) | Bal | Jack 1/4" | +/- 12 dB gain ctrl |
| | INPUT A impedance | 10 kΩ | | | |
| | INPUT B | Mono - 70 dB (MICRO level) | Bal. | XLR | +/- 12 dB gain ctrl |
| | INPUT B impedance | > 1,5 kΩ | | | |

OXYGEN 3 & OXYGEN 3 ST

| | | | | | |
|-------------------------|------------------------------------|----------------------------|--|--------|--|
| TELEPHONE MODULE | SEND / RECEIVE separation | 20 dB** | ** it can vary depending on telephone line characteristics | | |
| | In / out level on tel. line | - 6 dBm on 600 line imped. | | | |
| | Compensation mode | Electronic / automatic | | | |
| | Line connection | 2 wire, RJ11 connector | | | |
| | REC Tel output | 0 dB level | Unbal | PinRCA | |

| | | | | | |
|----------------------|----------------------------------|---------------------|----------|----------|--------------------------|
| MASTER MODULE | MASTER Output 1 & 2 | Stereo | El. Bal. | SubD 15P | ∞ to + 6 dB ctrl |
| | MASTER Output 3 and Fixed | Stereo | Unbal. | PinRCA | ∞ to + 6 dB ctrl (Out 3) |
| | MASTER Mono Outputs | Mono | Unbal | PinRCA | 0 dBm |
| | Nominal MST Output Level | 0 dBu (LINE) | | | |
| | MST output Impedance | 100 Ω | | | |
| | Noise (DIN Noise) | ≤ - 78 dBm | | | |
| | Crosstalk | < - 65 dB @ 10 kHz | | | |
| | THD+N | < - 70.5 dB @ 1 kHz | | | |

| | | | | | |
|-----------------------|------------------------|-------------------|--------|-----------|-------------------------|
| MONITOR MODULE | TUNER IN | Stereo Line | Unbal | PinRCA | ∞ to + 6 dB gain ctrl |
| | MONITOR Output | Spk (Stereo Line) | Unbal. | PinRCA | ∞ to + 6 dBm gain ctrl |
| | | Phones | Unbal. | Jack 1/4" | ∞ to + 12 dBm gain ctrl |
| | TALKBACK Output | Stereo Line | Unbal. | SubD 9p | |

| | | |
|----------------|--------------------------|--|
| GENERAL | AC VOLTAGE | 90 / 260V (50 – 60 Hz) - switching power supply |
| | POWER CONSUMPTION | 20 W |
| | WEIGHT | Around 5 Kg |

DIMENSIONS

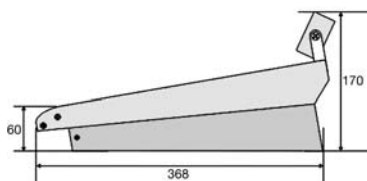

CONSOLE

OVERALL WIDTH

Oxygen 3 / 3 ST with wood finish touch 495 mm

DIMENSIONS

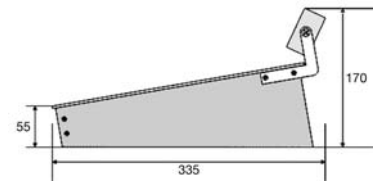

CONSOLE

OVERALL WIDTH

Oxygen 3 / 3 ST without wood finish touch 483 mm

Specifications, pictures and graphic layout of this leaflet are furnished for informational use only and are subject to change at any time without notice.



VIA C. DI SABBIBUONO 6/F • 40011 ANZOLA EMILIA • BOLOGNA • ITALY

+39 051 736555 • FAX +39 051 736170

e-mail: info@axeltechnology.com • web site: www.axeltechnology.com